

# THE COLLEC- TION

## TARIFA 2026.0

**JDM**  
seating

*Grupo Smobel*

# J.D.M. SILLERÍA, S.L.

DELEGACION CENTRAL

Polígono La Portalada II  
C/ Cordonera 5  
26006 LOGROÑO (La Rioja)

Tfno: 941 230752

Fax: 941 248977

e-mail:

[ismobel@ismobel.com](mailto:ismobel@ismobel.com)

<http://www.ismobel.com>

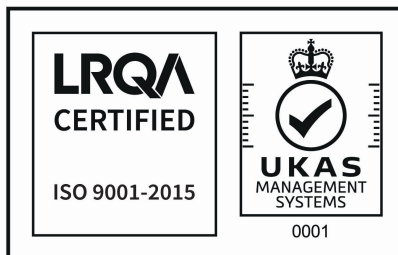

# **CONDICIONES DE COMPRA**

## **Precios**

**Los precios que aparecen en esta tarifa no incluyen el I.V.A.**

## **Transporte**

**La responsabilidad de las posibles incidencias surgidas en la entrega de los pedidos servidos por agencia (por orden nuestra o del cliente) recae únicamente en el responsable de la descarga o recepción de la mercancía; debiendo indicar en el albarán de recepción del transportista las posibles incidencias o roturas observadas. En cualquier caso se debe indicar siempre "pendiente de revisión".**

**Para pedidos inferiores a 600€ NETOS (entre productos de Ismobel, JDM Sillería y Forty) antes de aplicar el IVA se cobrará un importe adicional de 50€.**

## **Devoluciones**

**Los productos que, por parte del cliente, quieran devolverse a fábrica deberán:**

- consensuarse de mutuo acuerdo**
- enviarse en el embalaje original**
- enviarse a nuestras instalaciones a cargo del cliente**
- se devolverá un máximo del 90% del importe**

## **Plazos de entrega estimados para producto estándar**

- \* ISMOBEL: 4 semanas (excepto series indicadas en tarifa)**
- \* JDM SILLERÍA: 4 semanas**
- \* FORTY: 4 a 6 semanas (dependiendo del producto)**

## DIRECCIÓN



BONN 8



BELICE 9



TRENTO 10



ZURICH 11



BREMEN 12



BARI 13

## OPERATIVA



CÓRCEGA 17



NICEA 18



RODOS 19



BERNA 20



PALMA 21



AZORES 22



ODESA 23



ODESA M 24



ATENAS 25



SOFÍA 26



TORONTO 27



MOSCÚ 28

## COLECTIVIDADES

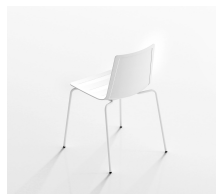

YALTA P 30



YALTA 34



SEVILLA 42



CRETA 44



VIENA 46



FRESNO 48



IOWA 50



VERONA 52



FLORIDA 54



BAHIA 55



PRAGA 56



MONACO 57

**CONTRACT & SOFT SEATING**



**BASEL 60**



**GLASGOW 64**



**TRIPOLI 65**



**VENECIA 66**



**MEMPHIS 67**



**ALBERTA 68**



**VANCOUVER 70**



**NIZA 72**



**COFFE TABLES NEREO 3 73**

**BANCADAS**



**YALTA PLÁSTICA 76**



**YALTA TAPIZADA 77**



**YALTA ASIENTO TAP. 78**



**YALTA MADERA 79**



**FRESNO 80**



**IOWA 82**



**JAMAICA 84**



**VIENA 86**



**LORCA 87**

**COMPLEMENTOS** 88

**TAPICERIAS** 89



# DIRECCIÓN



**BONN**

**8**



**BELICE**

**9**



**TRENTO**

**10**



**ZURICH**

**11**



**BREMEN**

**12**



**BARI**

**13**



### DATOS ESPECÍFICOS

MODELO	RESPALDO	ASIENTO	MECANISMO	BRAZOS	BASE	METRAJE	PESO	VOL.	UD.x BULTO
BONN A	Alto+Cabecero	Tapizado	Sincro 5 posiciones	Aluminio-Tapizado	Aluminio Pulido	1,7	22,7	0,73	1
BONN	Alto Tapizado	Tapizado	Sincro 5 posiciones	Aluminio-Tapizado	Aluminio Pulido	1,7	22,7	0,73	1
BONN B	Bajo Tapizado	Tapizado	Sincro 5 posiciones	Aluminio-Tapizado	Aluminio Pulido	1,7	21,3	0,56	1
BONN P	Bajo Tapizado	Tapizado	Fijo	Aluminio-Tapizado	Aluminio Pulido	0,7	15	0,1	1



**BONN A**  
115/127  
57  
50



**BONN**  
105/117  
57  
50



**BONN B**  
95/107  
57  
50



**BONN P**  
100  
57  
50

Altura / Height / Haut  
Anchura / Width / Large  
Fondo / Depth / Fond

### PVP POR TAPICERÍAS

MODELO	Grupo 1	Grupo 2	Grupo 3	Piel	T.Cliente
BONN A	591 €	650 €	714 €	893 €	583 €
BONN	567 €	623 €	685 €	857 €	560 €
BONN B	553 €	608 €	669 €	836 €	547 €
BONN P	533 €	588 €	645 €	807 €	528 €

Sillón direccional ergonómico alto con asiento, cabecero y respaldo con estructura metálica, tapizados sobre espuma inyectada de alta densidad. Brazos (tapizados en su parte superior) y base de aluminio pulido de 5 puntas con ruedas blandas de diámetro 65 mm. Mecanismo sincro autopesante y bloqueo de 5 posiciones. Sistema antishock. Disponible en respaldo alto, bajo y confidente con base fija de 4 radios.

### COMPLEMENTOS OPCIONALES

BRAZOS	BASE	RUEDAS	INCREMENTO DEL PRECIO
Pintados Blanco/Negro			-10,00 €
	Giratoria Pintada Blanco/Negro		0,00 €
		Con topes	-7,00 €



BELICE



BELICE B



BELICE P

### DATOS ESPECÍFICOS

MODELO	RESPALDO	ASIENTO	MECANISMO	BRAZOS	BASE	METRAJE	PESO	VOL.	UD.x BULTO
BELICE	Alto Tapizado	Tapizado	Basculante-Relax	Cromo-Tapizado	Aluminio Pulido	2,3	22	0,83	1
BELICE B	Bajo Tapizado	Tapizado	Basculante-Relax	Cromo-Tapizado	Aluminio Pulido	1,9	20	0,83	1
BELICE P	Bajo Tapizado	Tapizado	-----	Cromo-Tapizado	Patín Cromado	1,9	17	0,83	1



BELICE  
130/142  
61  
56



BELICE B  
105/117  
61  
56



BELICE P  
100  
63  
56

Altura / Height / Haut  
Anchura / Width / Large  
Fondo / Depth / Fond

### PVP POR TAPICERÍAS

MODELO	Grupo 1	Grupo 2	Grupo 3	Piel	T.Cliente
BELICE	462 €	508 €	559 €	715 €	453 €
BELICE B	445 €	490 €	538 €	689 €	435 €
BELICE P	407 €	448 €	492 €	632 €	398 €

Sillón direccional con monocarcasa de haya tapizada.

Mecanismo basculante-relax multibloqueo.

Brazos cromados y tapizados en la parte superior.

Confidente con patín en cromo y parte superior tapizada.

### COMPLEMENTOS OPCIONALES

#### RUEDAS

Blandas, 5 unidades

#### INCREMENTO DEL PRECIO

+6,00 €



TRENTA A



TRENTO B



TRENTO PA



TRENTO PC

### DATOS ESPECÍFICOS

MODELO	RESPALDO	ASIENTO	MECANISMO	BRAZOS	BASE	METRAJE	PESO	VOL.	UD.x BULTO
TRENTA A	Alto Tapizado	Tapizado	Basculante-Relax	Aluminio	Aluminio Pulido	1,5	16	0,80	1
TRENTO B	Bajo Tapizado	Tapizado	Basculante-Relax	Aluminio	Aluminio Pulido	1,2	13	0,60	1
TRENTO PA	Bajo Tapizado	Tapizado	-----	Aluminio	4 radios cromo	1,2	11	0,60	1
TRENTO PC	Bajo Tapizado	Tapizado	-----	Aluminio	Patín cromado	1,2	12	0,60	1



TRENTA A

125/137

57

51



TRENTO B

94/106

57

51



TRENTO PA

92/104

57

51



TRENTO PC

96

57

51

Altura / Height / Haut

Anchura / Width / Large

Fondo / Depth / Fond

### PVP POR TAPICERÍAS

MODELO	Grupo 1	Grupo 2	Grupo 3	Piel	T.Cliente
TRENTA A	414 €	455 €	502 €	643 €	406 €
TRENTO B	393 €	432 €	476 €	611 €	386 €
TRENTO PA	316 €	348 €	383 €	491 €	310 €
TRENTO PC	320 €	352 €	387 €	496 €	314 €

Sillón direccional con monocarcasa de haya tapizada.

Mecanismo basculante-relax 5 posiciones de bloqueo.

Brazos en aluminio pulido.

Confidente con base de 4 radios en acero cromado,

regulable en altura o con base de patín cromado.

### COMPLEMENTOS OPCIONALES

#### RUEDAS

Blandas, 5 unidades

#### INCREMENTO DEL PRECIO

+6,00 €

ZURICH 1



ZURICH 2

ZURICH 3  
base aluminio pulido



ZURICH 4

### DATOS ESPECÍFICOS

MODELO	RESPALDO	ASIENTO	MECANISMO	BRAZOS	BASE	METRAJE	PESO	VOL.	UD.x BULTO
ZURICH 1	Malla	Malla	Oscilante	No	Poliamida	---	8	0,5	1
ZURICH 2	Malla	Malla	Oscilante	Polipropileno	Poliamida	---	9	0,5	1
ZURICH 3	Malla	Malla	Oscilante	No	Aluminio Pintado	---	10	0,5	1
ZURICH 4	Malla	Malla	Oscilante	Polipropileno	Aluminio Pintado	---	11	0,5	1

## PLAZO DE ENTREGA: 4/6 SEMANAS

Colores malla: gris claro, gris oscuro, negro, marrón y turquesa



ZURICH 1

90/102

50

57

ZURICH 2

90/102

60

57

ZURICH 3

90/102

50

57

ZURICH 4

90/102

60

57

Altura / Height / Haut

Anchura / Width / Large

Fondo / Depth / Fond

MODELO	P.V.P.
ZURICH 1	448 €
ZURICH 2	461 €
ZURICH 3	478 €
ZURICH 4	493 €

Silla ergonómica con estructura inyectada en nylon y fibra de vidrio.

Mecanismo oscilante con bloqueo en posición de inicio.

Malla con 70% de poliéster y 30% de poliamida.

Distintas opciones de bases con ruedas o topes antideslizantes.

### COMPLEMENTOS OPCIONALES

BASE	ESTRUCTURA	RUEDAS	INCREMENTO DEL PRECIO
Base Aluminio Pulido Zurich 1 / 2			+46,00 €
Base Aluminio Pulido Zurich 3 / 4			+28,00 €
	Carcasa Blanca		+21,00 €
		Blandas Zurich 1 / 2	+6,00 €



BREMEN

### DATOS ESPECÍFICOS

MODELO	RESPALDO	ASIENTO	MECANISMO	BRAZOS	BASE	METRAJE	PESO	VOL.	UD.x BULTO
BREMEN	Malla	Tapizado	Sincro + Traslat	4D	Poliamida	0,6	16	0,30	1



BREMEN  
106/118  
50  
46/53

### MALLA COLOR NEGRO

Altura / Height / Haut

Anchura / Width / Large

Fondo / Depth / Fond

### PVP POR TAPICERÍAS

MODELO	Grupo 1	Grupo 2	Grupo 3	Piel	T.Cliente
BREMEN	410 €	431 €	453 €	508 €	406 €

Silla ergonómica con respaldo de malla regulable en altura. Soporte lumbar regulable en altura y profundidad. Mecanismo sincro de 5 posiciones autop pesante y regulable en intensidad. Brazos 4D incluidos. Regulación asiento en profundidad. Base de cinco puntas en poliamida reforzada con fibra de vidrio.

### COMPLEMENTOS OPCIONALES

ESTRUCTURA	BASE	RUEDAS	INCREMENTO DEL PRECIO
Terminado Blanco			+41,00 €
Cabecero Blanco			+50,00 €
Cabecero Negro			+44,00 €
	Aluminio Pulido		+41,00 €
		Blandas, 5 uds	+6,00 €



### DATOS ESPECÍFICOS

MODELO	RESPALDO	ASIENTO	MECANISMO	BRAZOS	BASE	METRAJE	PESO	VOL.	UD.xBULTO
BARI A	Alto Tapiz.+Cabecero	Tapizado	Sincro+Traslat	Opcionales	Poliamida	1,2	21	0,59	1
BARI	AltoTapizado	Tapizado	Sincro+Traslat	Opcionales	Poliamida	1,1	19	0,59	1



**BARI A**  
125/137  
50  
54/61



**BARI**  
105/115  
50  
54/61

CODIGO	BRAZOS	P.V.P.
BR-REG	REGULABLES EN ALTURA	+23,00 €
BR-REG-BLANCOS	REGULABLES EN ALTURA BLANCOS	+32,50 €
BR-REG 2D	REGULABLES 2D SOFT	+29,00 €
BR-REG-3D-DURO	REGULABLES 3D DURO	+30,00 €
BR-REG-3D-SOFT	REGULABLES 3D SOFT	+40,00 €
BR-REG-4D-SOFT	REGULABLES 4D SOFT	+50,00 €

Altura / Height / Haut  
Anchura / Width / Large  
Fondo / Depth / Fond

### PVP POR TAPICERÍAS

MODELO	Grupo 1	Grupo 2	Grupo 3	Piel	T.Cliente
BARI A	410 €	452 €	497 €	621€	406 €
BARI	320 €	353 €	388 €	485 €	317 €

Sillón ergonómico direccional con reposacabezas. Mecanismo sincro de 5 posiciones autopesante con antirretorno. Regulación en profundidad y en altura del asiento. Regulación en altura del respaldo. Espuma inyectada de alta densidad sobre lama metálica. Brazos 3D opcionales. Base de cinco puntas en poliamida con fibra de vidrio.

### COMPLEMENTOS OPCIONALES

RESPALDO	BASE	RUEDAS	INCREMENTO DEL PRECIO
Completamente tapizado(cualquier tapicería)			+44,00 €
	Aluminio pulido		+41,00 €
		Blandas, 5 uds.	+6,00 €



# OPERATIVA



CÓRCEGA 17



NICEA 18



RODOS 19



BERNA 20



PALMA 21



AZORES 22



ODESA 23



ODESA M 24



ATENAS 25



SOFIA 26



TORONTO 27



MOSCU 28





CORCEGA

CORCEGA A



### DATOS ESPECÍFICOS

MODELO	RESPALDO	ASIENTO	MECANISMO	BRAZOS	BASE	METRAJE	PESO	VOL.	UD.x BULTO
CORCEGA A	Malla c/cabecero	Tapizado	Sincro + Traslát	Opcionales	Poliamida	0,6	16	0,2	1
CORCEGA	Malla	Tapizado	Sincro + Traslát	Opcionales	Poliamida	0,6	16	0,16	1

Colores malla: negro, blanco, burdeos, gris, azul, naranja, verde, visón y melocotón



CÓRCEGA A

125/137

50

50/57



CÓRCEGA

106/118

50

50/57

Altura / Height / Haut

Anchura / Width / Large

Fondo / Depth / Fond

CODIGO	BRAZOS	P.V.P.
BR-REG	REGULABLES EN ALTURA	+23,00 €
BR-REG-BLANCOS	REGULABLES EN ALTURA BLANCOS	+32,50 €
BR-REG 2D	REGULABLES 2D SOFT	+29,00 €
BR-REG-3D-DURO	REGULABLES 3D DURO	+30,00 €
BR-REG-3D-SOFT	REGULABLES 3D SOFT	+40,00 €
BR-REG-4D-SOFT	REGULABLES 4D SOFT	+50,00 €

### PVP POR TAPICERÍAS

MODELO	Grupo 1	Grupo 2	Grupo 3	Piel	T.Cliente
CORCEGA A	303 €	318 €	334 €	367 €	300 €
CORCEGA	268 €	281 €	295 €	326 €	266 €

Silla ergonómica con respaldo de malla técnica clipada a una estructura perimetral inyectada en poliamida reforzada con fibra de vidrio. Mecanismo sincro de 5 posiciones regulable en intensidad con sistema antirretorno. Regulación del asiento en Profundidad. Tensor lumbar regulable en altura. Brazos opcionales. Base de cinco puntas en poliamida reforzada con fibra de vidrio.

### COMPLEMENTOS OPCIONALES

BASE	MECANISMO	RUEDAS	INCREMENTO DEL PRECIO
Aluminio Pulido			+41,00 €
	Sincro 5 autopresante c/regulación lateral		+50,00 €
	Sincro 4 posiciones autopresante		-5,00 €
		Blandas, 5 uds	+6,00 €



### DATOS ESPECÍFICOS

MODELO	RESPALDO	ASIENTO	MECANISMO	BRAZOS	BASE	METRAJE	PESO	VOL.	UD.x BULTO
NICEA A	Malla c/cabecero	Tapizado	Sincro	Opcionales	Poliamida	0,6	13	0,30	1
NICEA	Malla	Tapizado	Sincro	Opcionales	Poliamida	0,6	12	0,20	1

Colores malla(MALLA NICEA): blanco y negro  
Con incremento:turquesa, marrón, burdeos, y gris oscuro



NICEA A  
128/140  
51  
49

NICEA  
105/117  
51  
49

CODIGO	BRAZOS	P.V.P.
BR-REG	REGULABLES EN ALTURA	+23,00 €
BR-REG-BLANCOS	REGULABLES EN ALTURA BLANCOS	+32,50 €
BR-REG 2D	REGULABLES 2D SOFT	+29,00 €
BR-REG-3D-DURO	REGULABLES 3D DURO	+30,00 €
BR-REG-3D-SOFT	REGULABLES 3D SOFT	+40,00 €
BR-REG-4D-SOFT	REGULABLES 4D SOFT	+50,00 €

Altura / Height / Haut  
Anchura / Width / Large  
Fondo / Depth / Fond

### PVP POR TAPICERÍAS

MODELO	Grupo 1	Grupo 2	Grupo 3	Piel	T.Cliente
NICEA A	216 €	227 €	238 €	281 €	214 €
NICEA	170 €	179 €	187 €	221 €	167 €

Silla ergonómica con respaldo de malla técnica encavada en una estructura perimetral. Mecanismo sincro 5 posiciones regulable en intensidad y sistema antirretorno. Tensor lumbar regulable en altura. Opción de regulación del asiento en profundidad. Brazos opcionales. Base de 5 puntas en poliamida reforzada con fibra de vidrio.

### COMPLEMENTOS OPCIONALES

ESTRUCTURA	BASE	MECANISMO	RUEDAS	INCREMENTO DEL PRECIO
Cabecero Blanco				+10,00 €
Plásticos color Blanco				+41,00 €
Respaldo color Burdeos, Verde o Blanco				+36,00 €
Malla otros colores				+6,00 €
	Aluminio Pulido			+41,00 €
		4 posiciones autopesante		-5,00 €
		4 posiciones c/traslat autopesante		+5,00 €
		5 posiciones autopesante		+50,00 €
		5 posiciones autopesante c/traslat		+60,00 €
		Traslat		+21,00 €
			Blandas, 5 uds	+6,00 €



RODOS

### DATOS ESPECÍFICOS

MODELO	RESPALDO	ASIENTO	MECANISMO	BRAZOS	BASE	METRAJE	PESO	VOL.	UD.x BULTO
RODOS A	Malla c/cabecero	Tapizado	Sincro 4 posic.autop.	Opcionales	Poliamida	0,6	16	0,3	1
RODOS	Malla	Tapizado	Sincro 4 posic.autop.	Opcionales	Poliamida	0,6	15	0,2	1

Colores Malla (MALLA NICEA) : blanco y negro

Con incremento: turquesa, marrón, burdeos y gris oscuro

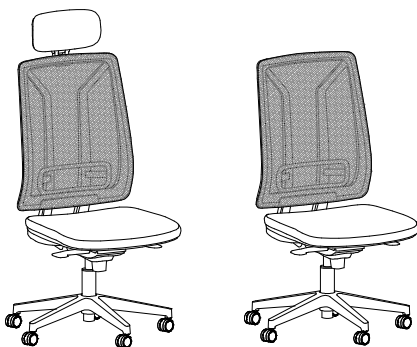

RODOS A

115/127

51

49

RODOS

100/112

51

49

CODIGO	BRAZOS	P.V.P.
BR-REG	REGULABLES EN ALTURA	+23,00 €
BR-REG-BLANCOS	REGULABLES EN ALTURA BLANCOS	+32,50 €
BR-REG 2D	REGULABLES 2D SOFT	+29,00 €
BR-REG-3D-DURO	REGULABLES 3D DURO	+30,00 €
BR-REG-3D-SOFT	REGULABLES 3D SOFT	+40,00 €
BR-REG-4D-SOFT	REGULABLES 4D SOFT	+50,00 €

Altura / Height / Haut

Anchura / Width / Large

Fondo / Depth / Fond

### PVP POR TAPICERÍAS

MODELO	Grupo 1	Grupo 2	Grupo 3	Piel	T.Cliente
RODOS A	227 €	239 €	252 €	283 €	224 €
RODOS	180 €	190 €	200 €	225 €	178 €

Silla ergonómica con respaldo de malla técnica encavada en una estructura perimetral. Mecanismo sincro 4 posiciones autopesante. Tensor lumbar regulable en altura. Brazos opcionales. Opción de regulación del asiento en profundidad. Base de 5 puntas en poliamida reforzada con fibra de vidrio. Cabecero opcional regulable en altura y orientación.

### COMPLEMENTOS OPCIONALES

MECANISMO	ESTRUCTURA	BASE	RUEDAS	INCREMENTO DEL PRECIO
4 posiciones autopesante + traslat				+10,00 €
5 posiciones				+10,00 €
5 posiciones + traslat				+26,00 €
5 posiciones autopesante(24 horas)				+55,00 €
5 posiciones autopesante + traslat(24 horas)				+65,00 €
	Terminado Blanco Rodos			+35,00 €
	Terminado Blanco Rodos A			+46,00 €
	Malla Otros colores			+6,00 €
		Base Aluminio Pulido		+41,00 €
			Blandas, 5 uds	+6,00 €



BERNA

### DATOS ESPECÍFICOS

MODELO	RESPALDO	ASIENTO	MECANISMO	BRAZOS	BASE	METRAJE	PESO	VOL.	UD.x BULTO
BERNA	Malla	Tapizado	Sincro	Opcionales	Poliamida	0,6	16	0,16	1

Colores malla: negro, blanco, burdeos, gris, azul, naranja, verde, visón y melocotón



CODIGO	BRAZOS	P.V.P.
BR-REG	REGULABLES EN ALTURA	+23,00 €
BR-REG-BLANCOS	REGULABLES EN ALTURA BLANCOS	+32,50 €
BR-REG 2D	REGULABLES 2D SOFT	+29,00 €
BR-REG-3D-DURO	REGULABLES 3D DURO	+30,00 €
BR-REG-3D-SOFT	REGULABLES 3D SOFT	+40,00 €
BR-REG-4D-SOFT	REGULABLES 4D SOFT	+50,00 €

BERNA  
99/111  
51  
46

Altura / Height / Haut

Anchura / Width / Large

Fondo / Depth / Fond

### PVP POR TAPIERÍAS

MODELO	Grupo 1	Grupo 2	Grupo 3	Piel	T.Cliente
BERNA	206 €	215 €	226 €	249 €	203 €

Silla ergonómica mecanismo sincro de 5 posiciones regulable en intensidad con sistema antirretorno.

Respaldo de malla técnica. Tensor lumbar regulable en altura. Base de poliamida reforzada con fibra de vidrio.

Brazos regulables opcionales.

### COMPLEMENTOS OPCIONALES

RUEDAS	MECANISMO	ESTRUCTURA	INCREMENTO DEL PRECIO
Blandas, 5 uds			+6,00 €
	Traslat		+21,00 €
	4 posiciones autopresante		-5,00 €
	4 posiciones c/traslat autopresante		+5,00 €
	5 posiciones autopresante		+50,00 €
	5 posiciones autopresante c/traslat		+60,00 €
		Base Aluminio Pulido	+41,00 €
		Terminado blanco	+41,00 €



PALMA

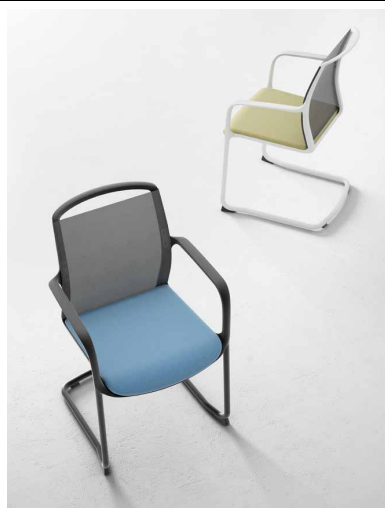

PALMA P

### DATOS ESPECÍFICOS

MODELO	RESPALDO	ASIENTO	MECANISMO	BRAZOS	BASE	DATOS ESPECÍFICOS			
						METRAJE	PESO	VOL.	UD.x BULTO
PALMA	Malla	Tapizado	Oscilante	Polipropileno	Poliamida	0,6	10	0,30	1
PALMA P	Malla	Tapizado	Fijo	Polipropileno	Patín	0,6	9	0,30	1



PALMA  
85/97  
59  
48



PALMA P  
90  
59  
48

### MALLA COLOR NEGRO

Altura / Height / Haut  
Anchura / Width / Large  
Fondo / Depth / Fond

### PVP POR TAPICERÍAS

MODELO	Grupo 1	Grupo 2	Grupo 3	Piel	T.Cliente
PALMA	247 €	259 €	273 €	302 €	243 €
PALMA P	230 €	242 €	255 €	280 €	227 €

Silla operativa giratoria con estructura inyectada en nylon y fibra de vidrio. Respaldo en malla técnica. Asiento tapizado. Mecanismo regulable en altura. Disponible en versión patín blanco o negro. Distintas opciones de bases y ruedas.

### COMPLEMENTOS OPCIONALES

ESTRUCTURA	BASE	INCREMENTO DEL PRECIO
Terminado blanco		+21,00 €
	Standard Poliamida Negra	-10,00 €
	Standard Poliamida Blanca	-10,00 €
	Aluminio Pulido	+41,00 €



AZORES A

AZORES

### DATOS ESPECÍFICOS

MODELO	RESPALDO	ASIENTO	MECANISMO	BRAZOS	BASE	METRAJE	PESO	VOL.	UD.x BULTO
AZORES A	Alto+Cabecero	Tapizado	Sincro	Opcionales	Poliamida	2	13	0,18	1
AZORES	Alto	Tapizado	Sincro	Opcionales	Poliamida	2	12,65	0,18	1



AZORES A

123/135

52

57



AZORES

102/114

52

57

CODIGO	BRAZOS	P.V.P.
BR-REG	REGULABLES EN ALTURA	+23,00 €
BR-REG-BLANCOS	REGULABLES EN ALTURA BLANCOS	+32,50 €
BR-REG 2D	REGULABLES 2D SOFT	+29,00 €
BR-REG-3D-DURO	REGULABLES 3D DURO	+30,00 €
BR-REG-3D-SOFT	REGULABLES 3D SOFT	+40,00 €
BR-REG-4D-SOFT	REGULABLES 4D SOFT	+50,00 €

Altura / Height / Haut

Anchura / Width / Large

Fondo / Depth / Fond

Silla ergonómica con mecanismo sincro 5 posiciones regulable en intensidad con antirretorno. Regulación en altura del respaldo con sistema de cremallera accionable mediante botón. Regulación en profundidad del asiento opcional. Posibilidad de brazos regulables. Base de poliamida reforzada con fibra de vidrio.

### PVP POR TAPIGERÍAS

MODELO	Grupo 1	Grupo 2	Grupo 3	Piel	T.Cliente
AZORES A	252 €	277 €	304 €	365 €	246 €
AZORES	216 €	238 €	261 €	314 €	212 €

### COMPLEMENTOS OPCIONALES

BASE	RUEDAS	MECANISMO	ESTRUCTURA	INCREMENTO DEL PRECIO
Aluminio Pulido				+41,00 €
	Blandas, 5 uds			+6,00 €
		Traslat		+21,00 €
		4 posiciones autopresante		-5,00 €
		4 posiciones c/traslat autopresante		+5,00 €
		5 posiciones autopresante		+50,00 €
		5 posiciones autopresante c/traslat		+60,00 €
			Carcasa+Base Blanca Azores A	+41,00 €
			Carcasa+Base Blanca Azores	+31,00 €
			Cabecero Blanco	+10,00 €



ODESA



ODESA T

### DATOS ESPECÍFICOS

MODELO	RESPALDO	ASIENTO	MECANISMO	BRAZOS	BASE	METRAJE	PESO	VOL.	UD.x BULTO
ODESA	Alto Tapizado	Tapizado	Sincro+Traslat	Opcionales	Poliamida	1,8	15,6	0,13	1
ODESA T	Alto Tapizado	Tapizado	Sincro+Traslat	Opcionales	Poliamida+Aro	1,8	19	0,13	1



**ODESA**  
100/112  
50  
56/62

**ODESA T**  
105/130  
50  
56/62

CODIGO	BRAZOS	P.V.P.
BR-REG	REGULABLES EN ALTURA	+23,00 €
BR-REG-BLANCOS	REGULABLES EN ALTURA BLANCOS	+32,50 €
BR-REG 2D	REGULABLES 2D SOFT	+29,00 €
BR-REG-3D-DURO	REGULABLES 3D DURO	+30,00 €
BR-REG-3D-SOFT	REGULABLES 3D SOFT	+40,00 €
BR-REG-4D-SOFT	REGULABLES 4D SOFT	+50,00 €

Altura / Height / Haut  
Anchura / Width / Large  
Fondo / Depth / Fond

Silla ergonómica mecanismo sincro de 5 posiciones regulable en intensidad con antirretorno. Regulación de respaldo en altura mediante sistema de cremallera y regulación del asiento en profundidad. Refuerzo lumbar regulable en altura. Brazos fijos o en poliamida o regulables. Base de cinco radios en poliamida reforzada con fibra de vidrio.

### PVP POR TAPICERÍAS

MODELO	Grupo 1	Grupo 2	Grupo 3	Piel	T.Cliente
ODESA	233 €	256 €	282 €	338 €	229 €
ODESA T	281 €	309 €	341 €	409 €	275 €

### COMPLEMENTOS OPCIONALES

MECANISMO	RUEDAS	ESTRUCTURA	INCREMENTO DEL PRECIO
Sincro 5 autop pesante c/regulación lateral			+50,00 €
Sincro 4 posiciones autop pesante			-5,00 €
	Blandas, 5 uds		+6,00 €
		Base Aluminio Pulido	+41,00 €
<b>EMBALAJE</b>	Embalaje caja		+10,00 €



### DATOS ESPECÍFICOS

MODELO	RESPALDO	ASIENTO	MECANISMO	BRAZOS	BASE	METRAJE	PESO	VOL.	UD.x BULTO
ODESA M	Malla Blanca o Negra	Tapizado	Sincro	Opcionales	Poliamida	0,6	16	0,20	1

Colores malla(MALLA NICEA): blanco y negro  
Con incremento: turquesa, marrón, burdeos, y gris oscuro



ODESA M  
100/112  
51  
49

Altura / Height / Haut  
Anchura / Width / Large  
Fondo / Depth / Fond

### PVP POR TAPICERÍAS

MODELO	Grupo 1	Grupo 2	Grupo 3	Piel	T.Cliente
ODESA M	177 €	188 €	200 €	221 €	175 €

CODIGO	BRAZOS	P.V.P.
BR-REG	REGULABLES EN ALTURA	+23,00 €
BR-REG-BLANCOS	REGULABLES EN ALTURA BLANCOS	+32,50 €
BR-REG 2D	REGULABLES 2D SOFT	+29,00 €
BR-REG-3D-DURO	REGULABLES 3D DURO	+30,00 €
BR-REG-3D-SOFT	REGULABLES 3D SOFT	+40,00 €
BR-REG-4D-SOFT	REGULABLES 4D SOFT	+50,00 €

Silla ergonómica con respaldo de malla técnica clipada a una estructura perimetral. Mecanismo sincro de 5 posiciones regulable en intensidad con antirretorno. Regulación de respaldo en altura mediante sistema de cremallera. Regulación del asiento en altura mediante pistón de gas. Refuerzo lumbar regulable en altura y en profundidad. Brazos regulables opcionales. Base de cinco radios en poliamida reforzada con fibra de vidrio. Opción de regulación del asiento en profundidad.

### COMPLEMENTOS OPCIONALES

MECANISMO	RUEDAS	ESTRUCTURA	INCREMENTO DEL PRECIO
Traslat			+21,00 €
Sincro 5 autopesante c/regulación lateral			+50,00 €
Sincro 4 posiciones autopesante			-5,00 €
Sincro 4 posiciones autopesante + Traslat			+5,00 €
	Blandas, 5 uds		+6,00 €
		Plásticos Blancos	+24,00 €
		Respaldo Verde / Burdeos	+20,00 €
		Cabecero Fijo Negro	+24,00 €
		Cabecero Fijo Blanco	+26,00 €
		Cabecero Regulable Negro	+35,00 €
		Cabecero Regulable Blanco	+40,00 €
		Malla otros colores	+6,00 €
		Base Aluminio Pulido	+41,00 €
		Lumbar Tapizado(Grupo 1)	+10,00 €
<b>EMBALAJE</b>	Embalaje caja		+10,00 €

ATENAS CP



ATENAS TCP



### DATOS ESPECÍFICOS

MODELO	RESPALDO	ASIENTO	MECANISMO	BRAZOS	BASE	METRAJE	PESO	VOL.	UD.x BULTO
ATENAS CP	Alto Tapizado	Tapizado	Contacto Permanente	Opcionales	Poliamida	0,6	12,15	0,13	1
ATENAS TCP	Alto Tapizado	Tapizado	Contacto Permanente	Opcionales	Poliamida+Aro	0,6	15	0,13	1



ATENAS CP

100/112

52

55

ATENAS T

115/140

52

55

CODIGO	BRAZOS	P.V.P.
BR-FIJOS	FIJOS	+32,50 €
BR-REG	REGULABLES EN ALTURA	+23,00 €
BR-REG 2D	REGULABLES 2D SOFT	+29,00 €
BR-REG-3D-DURO	REGULABLES 3D DURO	+30,00 €
BR-REG-3D-SOFT	REGULABLES 3D SOFT	+40,00 €
BR-REG-4D-SOFT	REGULABLES 4D SOFT	+50,00 €

Altura / Height / Haut

Anchura / Width / Large

Fondo / Depth / Fond

### PVP POR TAPICERÍAS

MODELO	Grupo 1	Grupo 2	Grupo 3	Piel	T.Cliente
ATENAS CP	173 €	190 €	210 €	251 €	170 €
ATENAS TCP	221 €	243 €	267 €	322 €	217 €

Silla ergonómica con contacto permanente. Regulación en altura del respaldo mediante sistema de cremallera.

Brazos fijos en poliamida o regulables opcionales.

Base de 5 radios en poliamida con fibra de vidrio.

Incluye ruedas blandas de diámetro 65 mm.

### COMPLEMENTOS OPCIONALES

#### ESTRUCTURA

Base Aluminio Pulido

+41,00 €

#### EMBALAJE

Embalaje caja

+10,00 €



SOFIA CP



SOFIA TCP

### DATOS ESPECÍFICOS

MODELO	RESPALDO	ASIENTO	MECANISMO	BRAZOS	BASE	METRAJE	PESO	VOL.	UD.x BULTO
SOFIA CP	Tapizado	Tapizado	Contacto permanente	Opcionales	Poliamida	0,6	11	0,13	1
SOFIA TCP	Tapizado	Tapizado	Contacto permanente	Opcionales	Poliamida+Aro	0,6	15	0,13	1



**SOFIA CP**  
102/114  
45  
45

**SOFIA TCP**  
117/132  
45  
45

Altura / Height / Haut  
Anchura / Width / Large  
Fondo / Depth / Fond

CODIGO	BRAZOS	P.V.P.
BR-REG	REGULABLES EN ALTURA	+23,00 €
BR-REG-BLANCOS	REGULABLES EN ALTURA BLANCOS	+32,50 €
BR-REG 2D	REGULABLES 2D SOFT	+29,00 €
BR-REG-3D-DURO	REGULABLES 3D DURO	+30,00 €
BR-REG-3D-SOFT	REGULABLES 3D SOFT	+40,00 €
BR-REG-4D-SOFT	REGULABLES 4D SOFT	+50,00 €

### PVP POR TAPICERÍAS

MODELO	Grupo 1	Grupo 2	Grupo 3	Piel	T.Cliente
SOFIA CP	150 €	165 €	181 €	217 €	147 €
SOFIA TCP	194 €	214 €	235 €	282 €	191 €

Silla ergonómica con versión de mecanismo contacto permanente. Regulación en altura del respaldo mediante cremallera. Brazos fijos o regulables. Base poliamida reforzada con fibra de vidrio.

### COMPLEMENTOS OPCIONALES

RUEDAS	ESTRUCTURA	INCREMENTO DEL PRECIO
Blandas, 5 uds		+6,00 €
	Carcasa + Base Blanca	+27,00 €
	Base Aluminio Pulido	+41,00 €
<b>EMBALAJE</b>	Embalaje caja	+10,00 €



TORONTO A



TORONTO

### DATOS ESPECÍFICOS

MODELO	RESPALDO	ASIENTO	MECANISMO	BRAZOS	BASE	METRAJE	PESO	VOL.	UD.x BULTO
TORONTO A	Alto c/reposacabezas	Tapizado	Sincro	Opcionales	Poliamida	1,3	13,85	0,73	1
TORONTO	Alto Tapizado	Tapizado	Sincro	Opcionales	Poliamida	1,3	13,85	0,73	1



TORONTO A  
120/132  
52  
55



TORONTO  
105/117  
52  
55

Altura / Height / Haut  
Anchura / Width / Large  
Fondo / Depth / Fond

### PVP POR TAPICERÍAS

MODELO	Grupo 1	Grupo 2	Grupo 3	Piel	T.Cliente
TORONTO A	324 €	356 €	392 €	471 €	318 €
TORONTO	277 €	305 €	336 €	402 €	271 €

Sillon ergonómico semidireccional con reposacabezas.  
Mecanismo sincro de 5 posiciones con sistema antirretorno.  
Asiento y respaldo con espuma inyectada de alta densidad.  
Brazos regulables opcionales. Base de cinco puntas de poliamida reforzada con fibra de vidrio. Asiento regulable en altura mediante pistón de gas, y respaldo regulable en altura mediante sistema de cremallera. Carcasas plásticas, brazos y bases disponibles también en color gris.

### COMPLEMENTOS OPCIONALES

BRAZOS	RUEDAS	MECANISMO	BASE	INCREMENTO DEL PRECIO
Regulables en altura(gris o negro)/cromado				+65,00 €
Regulables 2D Poliamida				+43,00 €
	Blandas, 5 uds			+6,00 €
		Traslat		+43,00 €
			Aluminio Pulido	+41,00 €
			Base+Carcasas color gris(incluye ruedas blandas)	+24,00 €



MOSCÚ A



MOSCÚ B

### DATOS ESPECÍFICOS

MODELO	RESPALDO	ASIENTO	MECANISMO	BRAZOS	BASE	METRAJE	PESO	VOL.	UD.x BULTO
MOSCU A	Alto Tapizado	Tapizado	Contacto permanente	Opcionales	Poliamida	0,6	8,5	0,1	1
MOSCU B	Bajo Tapizado	Tapizado	Contacto permanente	Opcionales	Poliamida	0,6	8,15	0,1	1
MOSCU BT	Bajo Tapizado	Tapizado	Elevación a Gas	Opcionales	Poliamida	0,6	9,6	0,1	1



MOSCU A

104/116

46

46



MOSCU B

87/99

46

46

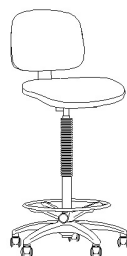

MOSCU BT

92/118

51

46

Altura / Height / Haut

Anchura / Width / Large

Fondo / Depth / Fond

### PVP POR TAPICERÍAS

MODELO	Grupo 1	Grupo 2	Grupo 3	Piel	T.Cliente
MOSCU A	114 €	126 €	138 €	166 €	112 €
MOSCU B	109 €	120 €	132 €	158 €	107 €
MOSCU BT	150 €	165 €	181 €	217 €	147 €

Silla operativa gama económica.

Mecanismo contacto permanente.

Elevación en altura de respaldo.

Base y brazos en poliamida.

### COMPLEMENTOS OPCIONALES

BRAZOS	RUEDAS	BASE	INCREMENTO DEL PRECIO
Moscú Fijos			+26,00 €
	Blandas, 5 uds		+6,00 €
		Aluminio Pulido	+41,00 €

# COLECTIVIDADES



YALTA P

30



YALTA

34



SEVILLA

42



CRETA

44



VIENA

46



FRESNO

48



IOWA

50



VERONA

52



FLORIDA

54



BAHIA

55



PRAGA

56



MONACO

57



Carcasa polipropileno



YALTA P1



YALTA P2



YALTA P3



YALTA P4



YALTA P5



YALTA P6



YALTA P6R



YALTA P7



YALTA P8



YALTA PB8



YALTA P9



YALTA P10



YALTA P11



YALTA P11R



YALTA P12

MODELO	RESPALDO	ASIENTO	BRAZOS	BASE	DATOS ESPECIFICOS			
					METRAJE	PESO	VOL.	UD.x BULTO
YALTA P1	Monocarcasa	Polipropileno	No	4 Patas Metálicas Bl,Ng	---	4,3	0,6	4
YALTA P2	Monocarcasa	Polipropileno	Metálicos	4 Patas Metálicas Bl,Ng	---	5,6	0,6	4
YALTA P3	Monocarcasa	Polipropileno	Opcionales	Patin Cromado o Negro	---	4,6	0,6	4
YALTA P4	Monocarcasa	Polipropileno	No	4 Patas Madera	---	4,5	0,6	2
YALTA P5	Monocarcasa	Polipropileno	Opcionales	Poliamida Negra	---	4,7	0,3	2
YALTA P6	Monocarcasa	Polipropileno	Opcionales	Piramidal Poliamida Ng	---	5,8	0,3	2
YALTA P6R	Monocarcasa	Polipropileno	Opcionales	Piramidal Poliamida Ng c/ruedas	---	5,8	0,3	2
YALTA P7	Monocarcasa	Polipropileno	Opcionales	Piramidal Madera	---	6,0	0,3	2
YALTA P8	Monocarcasa	Polipropileno	Opcionales	Taburete Cromado o Negro	---	6,5	0,3	1
YALTA PB8	Monocarcasa	Polipropileno	Opcionales	Taburete Bajo Cromado o Negro	---	6,3	0,3	1
YALTA P9	Monocarcasa	Polipropileno	No	Taburete Madera	---	6,0	0,3	1
YALTA P10	Monocarcasa	Polipropileno	Opcionales	Taburete Poliamida Ng	---	7,0	0,3	2
YALTA P11	Monocarcasa	Polipropileno	Opcionales	Piramidal Cromada 4 radios	---	7,0	0,3	2
YALTA P11R	Monocarcasa	Polipropileno	Opcionales	Piramidal Cromada 5 radios c/ruedas	---	9,0	0,3	2
YALTA P12	Monocarcasa	Polipropileno	Brazo + Pala	4 Patas Metálicas Ng	---	6,0	0,6	4

## POSIBILIDADES DE TAPIZADO

	GRUPO 1	GRUPO 2	GRUPO 3	PIEL	T.CLIENTE
Galleta Tapizada	25 €	28 €	31 €	39 €	24 €
Totalmente tapizada	38 €	42 €	46 €	58 €	37 €

POLIPROPILENO	
MODELO	
YALTA P1	82 €
YALTA P2	109 €
YALTA P3	96 €
YALTA P4	183 €
YALTA P5	107 €
YALTA P6	151 €
YALTA P6R	156 €
YALTA P7	301 €
YALTA P8	139 €
YALTA PB8	139 €
YALTA P9	240 €
YALTA P10	141 €
YALTA P11	226 €
YALTA P11R	286 €
YALTA P12	133 €

**COLORES POLIPROPILENO: Negro, Blanco,  
Gris, Curry, Azul, Terracota y Verde**

# YALTA POLIPROPILENO

## COLECTIVIDADES



YALTA P1

83  
53  
57  
48  
-  
47  
33



YALTA P2

83  
53  
57  
48  
67  
47  
33



YALTA P3

80  
51  
60  
48  
68 (opc)  
47  
33



YALTA P4

83  
53  
57  
48  
-  
47  
--

Altura / Height / Haut  
Anchura / Width / Large  
Fondo / Depth / Fond  
Altura asientos / Seat height / Hauteur siège  
Altura brazos / Arms height / Hauteur accoudoirs  
Anchura Asiento / Seat width / Largeur d'assise  
Anchura Respaldo / Backrest Width / Largeur dossier



YALTA P5

80/92  
60  
60  
48  
60  
47  
33



YALTA P6

81  
48  
60  
46  
65  
47  
33



YALTA P6R

83  
68  
68  
46  
-  
47  
33



YALTA P7

90  
50  
50  
76  
96  
47  
33

Altura / Height / Haut  
Anchura / Width / Large  
Fondo / Depth / Fond  
Altura asientos / Seat height / Hauteur siège  
Altura brazos / Arms height / Hauteur accoudoirs  
Anchura Asiento / Seat width / Largeur d'assise  
Anchura Respaldo / Backrest Width / Largeur dossier



YALTA P8

114  
50  
50  
76  
96  
47  
33



YALTA PB8

106  
50  
50  
67  
-  
47  
33



YALTA P9

118  
50  
50  
78  
-  
47  
33

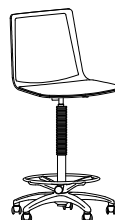

YALTA P10

85/110  
60  
60  
55/90  
75/100  
47  
33

Altura / Height / Haut  
Anchura / Width / Large  
Fondo / Depth / Fond  
Altura asientos / Seat height / Hauteur siège  
Altura brazos / Arms height / Hauteur accoudoirs  
Anchura Asiento / Seat width / Largeur d'assise  
Anchura Respaldo / Backrest Width / Largeur dossier

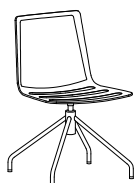

YALTA P11

81  
48  
60  
48  
65  
47  
33

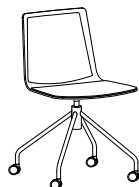

YALTA P11R

79  
48  
60  
48  
60  
47  
33



YALTA P12

79  
53  
57  
48  
-  
47  
33

Altura / Height / Haut  
Anchura / Width / Large  
Fondo / Depth / Fond  
Altura asientos / Seat height / Hauteur siège  
Altura brazos / Arms height / Hauteur accoudoirs  
Anchura Asiento / Seat width / Largeur d'assise  
Anchura Respaldo / Backrest Width / Largeur dossier

### COMPLEMENTOS OPCIONALES

ESTRUCTURA	RUEDAS	BRAZOS	INCREMENTO DEL PRECIO
Estructura sin brazos pintada otro ral: Aluminio, Curry, Terracota, Verde y Azul - YALTA P1			+15,00 €
Estructura con brazos pintada otro ral: Aluminio, Curry, Terracota, Verde y Azul - YALTA P2			+20,00 €
Estructura patín pintada otro ral: Aluminio, Blanco, Curry, Terracota, Verde y Azul - YALTA P3			+20,00 €
Taburetes metálicos otro ral: Aluminio, Blanco, Curry, Terracota, Verde y Azul - YALTA P8 - PB8			+20,00 €
Base Poliamida Blanca - YALTA P5			+19,00 €
Base Aluminio Pulido - YALTA P5			+40,00 €
Base Piramidal Poliamida Blanca - YALTA P6 - P6R			+28,00 €
Patas Madera Silla Barniz Otro Color: COLORES RAL - YALTA P4			+22,00 €
Patas Madera Silla Lacadas: COLORES RAL - YALTA P4			+30,00 €
Patas Madera Taburete Barniz Otro Color: COLORES RAL - YALTA P10			+31,00 €
Patas Madera Taburete Lacadas: COLORES RAL - YALTA P10			+39,00 €
	Ruedas Blandas - YALTA P5		+6,00 €
		Juego Brazos Negro/Blanco	+50,00 €
		Juego Brazos Otro Ral: Aluminio, Curry, Terracota, Verde y Azul	+60,00 €
		Juego Brazos Cromados	+63,00 €

### CORRESPONDENCIA COLOR-RAL

COLOR	RAL
BLANCO	9003
ALUMINIO	9006
NEGRO	9005
CURRY	1032
VERDE	6021
AZUL	5002
TERRACOTA	3016



Carcasa totalmente tapizada



YALTA 1



YALTA 2



YALTA 3



YALTA 4



YALTA 5



YALTA 6



YALTA 6R



YALTA 7



YALTA 8



YALTA 9



YALTA 10



YALTA 11



YALTA 12



YALTA 13



YALTA 13 R



YALTA 14

MODELO	RESPALDO	ASIENTO	BRAZOS	BASE	DATOS ESPECIFICOS			
					METRAJE	PESO	VOL.	UD.x BULTO
YALTA 1	Tapizado	Tapizado	No	4 Patas Metálicas BI,Ng	1,1	6,5	0,6	4
YALTA 2	Tapizado	Tapizado	Metálicos	4 Patas Metálicas BI,Ng	1,1	7,75	0,6	4
YALTA 3	Tapizado	Tapizado	Opcionales	Patin Cromado o Negro	1,1	6,75	0,6	4
YALTA 4	Tapizado	Tapizado	No	4 Patas Madera	1,1	6,65	0,6	2
YALTA 5	Tapizado	Tapizado	Opcionales	Poliamida Negra	1,1	6,9	0,3	2
YALTA 6	Tapizado	Tapizado	Opcionales	Piramidal Poliamida Negra	1,1	8	0,3	2
YALTA 6R	Tapizado	Tapizado	Opcionales	Piramidal Poliamida Negra c/ruedas	1,1	8	0,3	2
YALTA 7	Tapizado	Tapizado	Opcionales	Piramidal Madera	1,1	8,2	0,3	2
YALTA 8	Tapizado Bajo	Tapizado	Opcionales	Taburete Cromado o Negro	0,9	7,15	0,3	1
YALTA 9	Tapizado Alto	Tapizado	Opcionales	Taburete Cromado o Negro	1,1	8,65	0,3	1
YALTA 10	Tapizado Bajo	Tapizado	No	Taburete Madera	0,9	6,65	0,3	1
YALTA 11	Tapizado Alto	Tapizado	No	Taburete Madera	1,1	8,15	0,3	1
YALTA 12	Tapizado Alto	Tapizado	Opcionales	Taburete Poliamida Negro	1,1	9	0,3	2
YALTA 13	Tapizado	Tapizado	Opcionales	Piramidal Cromada 4 radios	1,1	8,50	0,3	2
YALTA 13R	Tapizado	Tapizado	Opcionales	Piramidal Cromada 5 radios c/ruedas	1,1	10,5	0,3	2
YALTA 14	Tapizado	Tapizado	Brazo+Pala	4 patas metálicas negro	1,1	8	0,6	4

MODELO	PVP POR TAPICERÍAS				
	Grupo 1	Grupo 2	Grupo 3	Piel	Tela Cliente
YALTA 1	141 €	156 €	171 €	206 €	139 €
YALTA 2	163 €	180 €	198 €	238 €	160 €
YALTA 3	155 €	171 €	189 €	225 €	152 €
YALTA 4	210 €	231 €	254 €	306 €	206 €
YALTA 5	147 €	161 €	177 €	213 €	143 €
YALTA 6	200 €	220 €	242 €	289 €	196 €
YALTA 6R	206 €	226 €	247 €	293 €	203 €
YALTA 7	321 €	354 €	389 €	467 €	315 €
YALTA 8	212 €	233 €	257 €	309 €	208 €
YALTA 9	218 €	240 €	264 €	317 €	214 €
YALTA 10	263 €	289 €	318 €	381 €	258 €
YALTA 11	269 €	296 €	325 €	390 €	264 €
YALTA 12	189 €	208 €	229 €	274 €	186 €
YALTA 13	262 €	287 €	316 €	381 €	259 €
YALTA 13R	316 €	348 €	383 €	460 €	313 €
YALTA 14	188 €	207 €	228 €	275 €	186 €



Carcasa de madera barnizada  
con asiento tapizado



YALTA 15



YALTA 16



YALTA 17



YALTA 18



YALTA 19



YALTA 20



YALTA 20R



YALTA 21



YALTA 22



YALTA 23



YALTA 24



YALTA 25



YALTA 26



YALTA 27



YALTA 27 R



YALTA 28

MODELO	RESPALDO	ASIENTO	BRAZOS	BASE	DATOS ESPECIFICOS			
					METRAJE	PESO	VOL.	UD.x BULTO
YALTA 15	Madera	Tapizado	No	4 Patas Metálicas BI,Ng	0,6	6,25	0,6	4
YALTA 16	Madera	Tapizado	Metálicos	4 Patas Metálicas BI,Ng	0,6	7,5	0,6	4
YALTA 17	Madera	Tapizado	Opcionales	Patin Cromado o Negro	0,6	6,5	0,6	4
YALTA 18	Madera	Tapizado	No	4 Patas Madera	0,6	6,4	0,6	2
YALTA 19	Madera	Tapizado	Opcionales	Poliamida Negra	0,6	6,65	0,3	2
YALTA 20	Madera	Tapizado	Opcionales	Piramidal Poliamida Negra	0,6	7,75	0,3	2
YALTA 20R	Madera	Tapizado	Opcionales	Piramidal Poliamida Negra c/ruedas	0,6	7,75	0,3	2
YALTA 21	Madera	Tapizado	Opcionales	Piramidal Madera	0,6	7,95	0,3	2
YALTA 22	Madera Bajo	Tapizado	Opcionales	Taburete Cromado o Negro	0,6	6,9	0,3	1
YALTA 23	Madera Alto	Tapizado	Opcionales	Taburete Cromado o Negro	0,6	8,4	0,3	1
YALTA 24	Madera Bajo	Tapizado	No	Taburete Madera	0,6	6,4	0,3	1
YALTA 25	Madera Alto	Tapizado	No	Taburete Madera	0,6	7,9	0,3	1
YALTA 26	Madera Alto	Tapizado	Opcionales	Taburete Poliamida Negro	0,6	8,75	0,3	2
YALTA 27	Madera	Tapizado	Opcionales	Piramidal Cromada 4 radios	0,6	8,5	0,3	2
YALTA 27R	Madera	Tapizado	Opcionales	Piramidal Cromada 5 radios c/ruedas	0,6	10,5	0,3	2
YALTA 28	Madera	Tapizado	Brazo+Pala	4 patas metálicas negro	0,6	8	0,6	4

### PVP POR TAPICERÍAS

MODELO	Grupo 1	Grupo 2	Grupo 3	Piel	Tela Cliente
YALTA 15	174 €	183 €	192 €	221 €	171 €
YALTA 16	197 €	207 €	217 €	250 €	194 €
YALTA 17	189 €	198 €	208 €	240 €	185 €
YALTA 18	244 €	257 €	269 €	309 €	240 €
YALTA 19	187 €	196 €	206 €	235 €	182 €
YALTA 20	237 €	249 €	260 €	299 €	231 €
YALTA 20R	243 €	255 €	267 €	308 €	237 €
YALTA 21	358 €	376 €	395 €	454 €	352 €
YALTA 22	244 €	256 €	269 €	309 €	240 €
YALTA 23	254 €	267 €	280 €	322 €	249 €
YALTA 24	293 €	308 €	323 €	371 €	287 €
YALTA 25	307 €	323 €	338 €	388 €	301 €
YALTA 26	223 €	234 €	246 €	283 €	219 €
YALTA 27	300 €	315 €	331 €	380 €	297 €
YALTA 27R	354 €	371 €	390 €	449 €	350 €
YALTA 28	219 €	230 €	242 €	279 €	216 €



Carcasa de madera barnizada



YALTA 30



YALTA 31



YALTA 32



YALTA 33



YALTA 34



YALTA 35



YALTA 35R



YALTA 36



YALTA 37



YALTA 38



YALTA 39



YALTA 40



YALTA 41



YALTA 42



YALTA 42 R



YALTA 43

MODELO	RESPALDO	ASIENTO	BRAZOS	BASE	DATOS ESPECIFICOS			
					METRAJE	PESO	VOL.	UD.x BULTO
YALTA 30	Monocarcasa	Madera	No	4 Patas Metálicas Bl,Ng	---	5,45	0,6	4
YALTA 31	Monocarcasa	Madera	Metálicos	4 Patas Metálicas Bl,Ng	---	6,7	0,6	4
YALTA 32	Monocarcasa	Madera	Opcionales	Patin Cromado o Negro	---	5,7	0,6	4
YALTA 33	Monocarcasa	Madera	No	4 Patas Madera	---	5,6	0,6	2
YALTA 34	Monocarcasa	Madera	Opcionales	Poliamida Negra	---	5,85	0,3	2
YALTA 35	Monocarcasa	Madera	Opcionales	Piramidal Poliamida Negra	---	6,95	0,3	2
YALTA 35R	Monocarcasa	Madera	Opcionales	Piramidal Poliamida Negra c/ruedas	---	6,95	0,3	2
YALTA 36	Monocarcasa	Madera	Opcionales	Piramidal Madera	---	7,15	0,3	2
YALTA 37	Monocarcasa Bajo	Madera	Opcionales	Taburete Cromado o Negro	---	6,1	0,3	1
YALTA 38	Monocarcasa Alto	Madera	Opcionales	Taburete Cromado o Negro	---	7,6	0,3	1
YALTA 39	Monocarcasa Bajo	Madera	No	Taburete Madera	---	5,6	0,3	1
YALTA 40	Monocarcasa Alto	Madera	No	Taburete Madera	---	7,1	0,3	1
YALTA 41	Monocarcasa Alto	Madera	Opcionales	Taburete Poliamida Negro	---	7,95	0,3	2
YALTA 42	Monocarcasa	Madera	Opcionales	Piramidal Cromada 4 radios	---	8,5	0,3	2
YALTA 42R	Monocarcasa	Madera	Opcionales	Piramidal Cromada 5 radios c/ruedas	---	10,5	0,3	2
YALTA 43	Monocarcasa	Madera	Brazo+Pala	4 patas metálicas negro	---	8	0,6	4

MADERA HAYA BARNIZADA	
MODELO	BARNIZ NATURAL
YALTA 30	145 €
YALTA 31	168 €
YALTA 32	159 €
YALTA 33	214 €
YALTA 34	154 €
YALTA 35	205 €
YALTA 35R	211 €
YALTA 36	324 €
YALTA 37	212 €
YALTA 38	223 €
YALTA 39	260 €
YALTA 40	270 €
YALTA 41	193 €
YALTA 42	263 €
YALTA 42R	320 €
YALTA 43	191 €



**YALTA 1**  
83  
53  
57  
48  
-  
47  
33



**YALTA 2**  
83  
53  
57  
48  
67  
47  
33



**YALTA 3**  
80  
51  
60  
48  
68 (opc)  
47  
33



**YALTA 4**  
83  
53  
57  
48  
-  
47  
--

Altura / Height / Haut  
Anchura / Width / Large  
Fondo / Depth / Fond  
Altura asientos / Seat height / Hauteur siège  
Altura brazos / Arms height / Hauteur accoudoirs  
Anchura Asiento / Seat width / Largeur d'assise  
Anchura Respaldo / Backrest Width / Largeur dossier



**YALTA 5**  
80/92  
60  
60  
48/60  
60/80 (opc)  
47  
33



**YALTA 6**  
81  
48  
60  
46  
65  
47  
33



**YALTA 7**  
83  
68  
68  
46  
-  
47  
33



**YALTA 8**  
96  
50  
50  
80  
96  
47  
33

Altura / Height / Haut  
Anchura / Width / Large  
Fondo / Depth / Fond  
Altura asientos / Seat height / Hauteur siège  
Altura brazos / Arms height / Hauteur accoudoirs  
Anchura Asiento / Seat width / Largeur d'assise  
Anchura Respaldo / Backrest Width / Largeur dossier



**YALTA 9**  
118  
50  
50  
80  
96  
47  
33



**YALTA 10**  
116  
50  
50  
78  
-  
47  
33



**YALTA 11**  
91  
50  
50  
78  
-  
47  
33



**YALTA 12**  
85/110  
60  
60  
55/90  
75/100 (opc)  
47  
33

Altura / Height / Haut  
Anchura / Width / Large  
Fondo / Depth / Fond  
Altura asientos / Seat height / Hauteur siège  
Altura brazos / Arms height / Hauteur accoudoirs  
Anchura Asiento / Seat width / Largeur d'assise  
Anchura Respaldo / Backrest Width / Largeur dossier



**YALTA 13**  
81  
48  
60  
48  
65 (opc)  
47  
33



**YALTA 13R**  
79/91  
48  
60  
48/60  
60/80 (opc)  
47  
33



**YALTA 14**  
83  
53  
57  
48  
-  
47  
33

Altura / Height / Haut  
Anchura / Width / Large  
Fondo / Depth / Fond  
Altura asientos / Seat height / Hauteur siège  
Altura brazos / Arms height / Hauteur accoudoirs  
Anchura Asiento / Seat width / Largeur d'assise  
Anchura Respaldo / Backrest Width / Largeur dossier

### COMPLEMENTOS OPCIONALES

ESTRUCTURA	ASIENTO	RUEDAS	BRAZOS	INCREMENTO DEL PRECIO
Estructura sin brazos pintada otro ral: Aluminio, Amarillo curry, Terracota, Verde y Azul (1,15 y30)				+15,00 €
Estructura con brazos pintada otro ral: Aluminio, Amarillo curry, Terracota, Verde y Azul (2,16 y 31)				+20,00 €
Estructura patín pintada otro ral: Aluminio, Blanco, Amarillo curry, Terracota, Verde y Azul (3,17 y 32)				+20,00 €
Taburetes metálicos otro ral: Aluminio, Blanco, Amarillo curry, Terracota, Verde y Azul (8, 9, 22, 23, 37 y 38)				+20,00 €
Base Poliamida Blanca (5,19 y 34)				+19,00 €
Base Aluminio Pulido (5,19 y 34)				+40,00 €
Base Piramidal Poliamida Blanca (6,6R,20,20R,35 y 35R)				+25,00 €
Patas Madera Silla Barniz Otro Color: COLORES RAL (4,18 y 33)				+22,00 €
Patas Madera Silla Lacadas: COLORES RAL (4,18 y 33)				+30,00 €
Patas Madera Taburete Barniz Otro Color: COLORES RAL (10,11,24,25,39 y 40)				+31,00 €
Patas Madera Taburete Lacadas: COLORES RAL (10,11,24,25,39 y 40)				+39,00 €
Carcasa Terminación Barniz Otro Tono				+18,00 €
Carcasa Terminación Lacada: Blanco o Negro				+50,00 €
Ruedas Blandas (5,19 y 34)				+6,00 €
Juego Brazos Negro/Blanco				+50,00 €
Juego Brazos otro ral: Aluminio, Amarillo curry, Terracota, Verde y Azul				+60,00 €
Juego Brazos Cromados				+63,00 €

### CORRESPONDENCIA COLOR-RAL

COLOR	RAL
BLANCO	9003
ALUMINIO	9006
NEGRO	9005
CURRY	1032
VERDE	6021
AZUL	5002
TERRACOTA	3016



MODELO	RESPALDO	ASIENTO	BRAZOS	BASE
SEVILLA 1-2-3 (sin brazos)	Tapizado(1), Malla (2), Madera (3)	Tapizado(1,2), Madera (3)	-----	4 patas metálicas aluminio
SEVILLA 4-5 (con brazos)	Tapizado(4), Madera (5)	Tapizado(4), Madera (5)	En estructura	4 patas metálicas
SEVILLA 6 (con brazos)	Tapizado	Tapizado	En estructura	Poliamida Giratoria
SEVILLA 7 (sin brazos)	Malla	Madera	-----	4 patas metálicas aluminio
SEVILLA 8 (sin brazos)	Madera	Tapizado	-----	4 patas metálicas aluminio
SEVILLA 9 (con brazos)	Madera	Tapizado	En estructura	4 patas metálicas

COLOR ESTRUCTURA SEVILLA: Negro, blanco, aluminio

COLORES MALLA: Negro, azul, burdeos, blanco y gris



SEVILLA  
83  
53  
52

SEVILLA C/BRAZOS  
83  
57  
52

SEVILLA MALLA  
83  
53  
52

SEVILLA GIRATORIA  
83/95  
53  
52

SEVILLA BASE PIRAMIDAL  
85  
53  
52

Altura / Height / Haut  
Anchura / Width / Large  
Fondo / Depth / Fond

### PVP POR TAPICERÍAS

MODELO	Grupo 1	Grupo 2	Grupo 3	Piel	T.Cliente
SEVILLA 1	183 €	201 €	220 €	264 €	179 €
SEVILLA 2	188 €	197 €	207 €	228 €	186 €
SEVILLA 4	194 €	213 €	235 €	281 €	190 €
SEVILLA 6	230 €	253 €	278 €	333 €	225 €
SEVILLA 8	222 €	233 €	245 €	270 €	220 €
SEVILLA 9	235 €	247 €	259 €	284 €	233 €
<b>MADERA LACADA</b>					
SEVILLA 3	273 €				
SEVILLA 5	284 €				
SEVILLA 7	235 €				

### DATOS ESPECÍFICOS

METRAJE	PESO	VOL.	UD.x BULTO
1	6,75	0,59	3
0,6	6,5	0,59	3
1	8,45	0,53	4
1	11,5	0,5	1
0,6	8	0,53	3
0,6	12	0,53	1
---	6,7	0,59	3
---	8,4	0,53	4
---	6	0,6	3

Silla de colectividades apilable de 4 patas realizada en tubo de acero oval de 30x16 acabado en pintura epoxi color blanco, negro, aluminio o cromado. Asiento y respaldo tapizado o lacado, fabricado en madera contrachapada con espesor variable. Posibilidad de incorporar respaldo de malla, brazos en estructura, con pistón a gas y base giratoria con ruedas.

### COMPLEMENTOS OPCIONALES

BASE	INCREMENTO DEL PRECIO
Estructura cromada en Sevilla 1-2-3-7-8	+59,00 €
Estructura cromada en Sevilla 4-5-9	+76,00 €
Base Piramidal Giratoria de poliamida(Sevilla 6)	+48,00 €
Base Piramidal Giratoria de poliamida con ruedas(Sevilla 6)	+65,00 €



BASE PIRAMIDAL POLIAMIDA



CRETA 2

CRETA 1



CRETA 3

CRETA 4(c/rc/ruedas)



CRETA 5



CRETA 8

### DATOS ESPECÍFICOS

MODELO	ASIENTO / RESPALDO	BRAZOS	BASE	METRAJE	PESO	VOL.	UD.x BULTO
CRETA 1	Monocarcasa Polipropileno	Incluidos	4 patas madera	---	5	0,45	1
CRETA 2	Monocarcasa Tapizado Asiento	Incluidos	4 patas madera	0,6	5	0,45	1
CRETA 3	Monocarcasa Polipropileno	Incluidos	4 radios poliamida piramidal negra	---	5,1	0,45	1
CRETA 4	Monocarcasa Tapizado Asiento	Incluidos	4 radios poliamida piramidal negra	0,6	5,1	0,45	1
CRETA 5	Monocarcasa Polipropileno	Incluidos	4 radios cromada piramidal	---	7	0,45	1
CRETA 6	Monocarcasa Tapizado Asiento	Incluidos	4 radios cromada piramidal	0,6	7	0,45	1
CRETA 7	Monocarcasa Polipropileno	Incluidos	5 radios cromada piramidal c/ruedas	---	7,5	0,45	1
CRETA 8	Monocarcasa Tapizado Asiento	Incluidos	5 radios cromada piramidal c/ruedas	0,6	7,5	0,45	1

COLORES MONOCARCASA: blanco, negro, rojo, azul

OTROS COLORES: CONSULTAR



**CRETA 1/2**

80  
57  
52



**CRETA 3/4**

80  
57  
52



**CRETA 5/6**

80  
57  
52



**CRETA 7/8**

78/90  
57  
52

Altura / Height / Haut  
Anchura / Width / Large  
Fondo / Depth / Fond

### PVP POR TAPICERÍAS

MODELO	Grupo 1	Grupo 2	Grupo 3	Piel	T.Cliente
CRETA 2	217 €	228 €	239 €	263 €	215 €
CRETA 4	196 €	206 €	216 €	238 €	194 €
CRETA 6	234 €	246 €	258 €	284 €	232 €
CRETA 8	280 €	294 €	309 €	340 €	277 €
<b>POLIPROPILENO</b>					
CRETA 1			195 €		
CRETA 3			176 €		
CRETA 5			211 €		
CRETA 7			258 €		

Silla de colectividad.

Monocarcasa inyectada en poliamida reforzada con fibra de vidrio. Posibilidad de tapizar asiento y distintas bases adaptables.

**COLORES MONOCARCASA:** blanco, negro, rojo, azul

### COMPLEMENTOS OPCIONALES

BASE	RUEDAS	INCREMENTO DEL PRECIO
Base Poliamida Piramidal Blanca Creta 3 / 4		+25,00 €
	Creta 3 / 4 con ruedas	+12,00 €



VIENA 1



VIENA 2



VIENA 3(c/c/ruedas



VIENA G



VIENA T



VIENA 5

VIENA 4  
Asiento Tapizado



VIENA P

### DATOS ESPECÍFICOS

MODELO	ASIENTO / RESPALDO	BRAZOS	BASE	METRAJE	PESO	VOL.	UD.x BULTO
VIENA 1	Monocarcasa Polipropileno	----	4 patas metálicas	---	5	0,54	5
VIENA 2	Monocarcasa Polipropileno	Sí	4 patas metálicas	---	6	0,54	5
VIENA 3	Monocarcasa Polipropileno	----	4 radios poliamida piramidal negra	---	8	0,54	1
VIENA 4	Monocarcasa Polipropileno	----	4 radios cromada piramidal	---	7	0,6	1
VIENA 5	Monocarcasa Polipropileno	----	5 radios cromada piramidal c/ruedas	---	7	0,6	1
VIENA T	Monocarcasa Polipropileno	----	Taburete fijo cromo	---	7	0,6	4
VIENA G	Monocarcasa Polipropileno	----	Poliamida	---	7	0,6	1
VIENA P	Monocarcasa Polipropileno	Pala	4 patas metálicas negras	---	7	0,6	2

COLORES ESTRUCTURA METÁLICA: \* VIENA 1: estándar: blanco y negro; con incremento: gris

\* VIENA 2: estándar: blanco y negro.

COLORES CARCASAS: \* ESTÁNDAR: gris, blanco, antracita, verde, azul

\* CON INCREMENTO: zanahoria y amarillo

COLORES BASE PIRAMIDAL VIENA 3: negro. Con incremento: blanco



VIENA 1	VIENA 2	VIENA 3	VIENA 4	VIENA 5	VIENA T	VIENA G	VIENA P	
81	81	84	85	84/96	115	81/93	81	Altura / Height / Haut
53	54	53	53	53	53	53	54	Anchura / Width / Large
52	52	52	52	52	52	52	52	Fondo / Depth / Fond

### COLORES CARCASAS:

- \* ESTÁNDAR: gris, blanco, antracita, verde, azul
- \* CON INCREMENTO: zanahoria y amarillo

### COLORES ESTRUCTURA METÁLICA:

- \* VIENA 1: ESTÁNDAR: blanco y negro
- CON INCREMENTO: gris
- \* VIENA 2: ESTÁNDAR :blanco y negro

### COLORES BASE PIRAMIDAL

VIENA 3: blanco y negro

MODELO	POLIPROPILENO
VIENA 1	87 €
VIENA 2	147 €
VIENA 3	172 €
VIENA 4	210 €
VIENA 5	258 €
VIENA T	163 €
VIENA G	105 €
VIENA P	192 €

*Silla de colectividades*

*Monocarcasa inyectada en polipropileno.*

*Diferentes opciones de bases y terminaciones.*

### COMPLEMENTOS OPCIONALES

	INCREMENTO DEL PRECIO
Asiento Tapizado (Grupo 1)	+23,00 €
Base piramidal con ruedas (Viena 3)	+12,00 €
Estructura color gris (Viena 1 y 2)	+5,00 €
Viena G base blanca	+13,00 €
Colores Carcasa Zanahoria y Amarillo	+6,00 €
Base Poliamida Piramidal Blanca Viena 3	+25,00 €



FRESNO 1 c/brazos

FRESNO 1  
Respaldo Malla  
Asiento Tapizado



FRESNO 1 Asiento Tapizado



FRESNO 6  
Respaldo Malla  
Asiento Tapizado

FRESNO 7 c/brazos  
Asiento Tapizado

FRESNO TG c/brazos  
Asiento Tapizado



FRESNO 8

FRESNO 9 c/brazos  
Asiento Tapizado  
Respaldo Malla



FRESNO G c/pala



FRESNO TF



FRESNO P

**COLORES ESTRUCTURA METÁLICA FRESNO 1: negro CON INCREMENTO: blanco, aluminio y cromo**

**COLORES POLIPROPILENO: negro, blanco y gris. CON INCREMENTO: amarillo, verde, zanahoria y azul**

**COLORES BASE PIRAMIDAL POLIAMIDA: negro. Con incremento: blanco**

MODELO	RESPALDO	ASIENTO	BRAZOS	BASE
FRESNO 1	Polipropileno	Polipropileno	Opcionales	4 patas metálicas
FRESNO 6	Polipropileno	Polipropileno	Opcionales	4 radios cromada piramidal
FRESNO 7	Polipropileno	Polipropileno	Opcionales	5 radios cromada piramidal c/ruedas
FRESNO 8	Polipropileno	Polipropileno	Opcionales	4 radios poliamida piramidal negra
FRESNO 9	Polipropileno	Polipropileno	Opcionales	4 radios poliamida piramidal negra c/ruedas
FRESNO G	Polipropileno	Polipropileno	Opcionales	Poliamida Negra
FRESNO TF	Polipropileno	Polipropileno	Opcionales	Taburete Fijo Cromo
FRESNO TG	Polipropileno	Polipropileno	Opcionales	Poliamida Negra + Aro cromo
FRESNO P	Polipropileno	Polipropileno	Opcionales	Patín cromado

**COLORES MALLA: Negro, blanco, burdeos, azul, naranja, verde, visión, gris y melocotón.**



FRESNO 1	FRESNO 1 CON BRAZOS	FRESNO 1 RESPALDO MALLA	FRESNO 6	FRESNO 7	FRESNO 8/9	FRESNO G	FRESNO TF	FRESNO TG	FRESNO P	
82	82	82	87	86/98	85	80/92	118	85/110	86	Altura / Height / Haut
50	58	50	50	50	50	50	52	50	50	Anchura / Width / Large
56	56	56	56	56	56	56	52	56	54	Fondo / Depth / Fond

PVP	
MODELO	POLIPROPILENO: Negro, gris, blanco
FRESNO 1	92 €
FRESNO 6	221 €
FRESNO 7	288 €
FRESNO 8	190 €
FRESNO 9	202 €
FRESNO G	136 €
FRESNO TF	144 €
FRESNO TG	176 €
FRESNO P	146 €

DATOS ESPECÍFICOS			
METRAJE	PESO	VOL.	UD.x BULTO
---	4	0,54	5
---	8	0,54	1
---	8	0,54	1
---	8	0,54	1
---	8	0,54	1
---	5,6	0,56	1
---	6	0,6	4
---	8,5	0,56	1
---	7	0,56	4

Silla de colectividades con asiento y respaldo fabricado en polipropileno. Diferentes bases disponibles. Brazos opcionales en polipropileno reforzados en acero.

Posibilidad de tapizar asiento y realizar el respaldo en malla de diferentes colores.

Se pueden unir entre ellas y colocar pala. Silla apilable y transportable mediante carro portasillas.

CODIGO	COMPLEMENTO	P.V.P.
FR-AT	ASIENTO TAPIZADO(GRUPO 1)	+15,00 €
FR-RM	RESPALDO MALLA	+30,00 €
FR-BF	BRAZOS FIJOS	+20,00 €
FR-PA	POLIPROPILENO AMARILLO	+6,00 €
FR-PV	POLIPROPILENO VERDE	+6,00 €
FR-PJ	POLIPROPILENO ZANAHORIA	+6,00 €
FR-PZ	POLIPROPILENO AZUL	+6,00 €

COMPLEMENTOS OPCIONALES		
BRAZOS	ESTRUCTURA	INCREMENTO DEL PRECIO
Juego brazos + pala(indicar dcha o izda)		+70,00 €
Juego Brazos Azul, Amarillo, Verde o Zanahoria		+6,00 €
Ral 9006/ Blanco (Fresno 1)		+7,00 €
Cromada (Fresno 1)		+10,00 €
Fresno G base Blanca		+13,00 €
Base aluminio pulido para Fresno G o Fresno TG		+41,00 €
Base Poliamida Piramidal Blanca Fresno 8/9		+25,00 €
Mecanismo + Pala Modelo Fresno G		+173,00 €
Carro portasillas		+113,00 €
Enganche unión		+11,00 €



IOWA 1



IOWA 1 c/brazos  
Asiento Tapizado



IOWA 6  
Asiento Tapizado

IOWA 7 c/brazos  
Asiento Tapizado



IOWA G  
cc/brazos



IOWA TF  
Asiento Tapizado



IOWA TG



IOWA P c/brazos  
Asiento Tapizado

**COLORES ESTRUCTURA METÁLICA IOWA 1:** negro **CON INCREMENTO:** blanco, aluminio y cromo

**COLORES POLIPROPILENO:** negro, blanco y gris. **CON INCREMENTO:** amarillo, verde, zanahoria y azul

**COLORES BASE PIRAMIDAL POLIAMIDA:** negro. **Con incremento:** blanco

MODELO	RESPALDO	ASIENTO	BRAZOS	BASE
IOWA 1	Polipropileno	Polipropileno	Opcionales	4 patas metálicas
IOWA 6	Polipropileno	Polipropileno	Opcionales	4 radios cromada piramidal
IOWA 7	Polipropileno	Polipropileno	Opcionales	5 radios cromada piramidal c/ruedas
IOWA 8	Polipropileno	Polipropileno	Opcionales	4 radios poliamida piramidal negra
IOWA 9	Polipropileno	Polipropileno	Opcionales	4 radios poliamida piramidal negra c/ruedas
IOWA G	Polipropileno	Polipropileno	Opcionales	Poliamida Negra
IOWA TF	Polipropileno	Polipropileno	Opcionales	Taburete Fijo Cromo
IOWA TG	Polipropileno	Polipropileno	Opcionales	Poliamida Negra + Aro Cromo
IOWA P	Polipropileno	Polipropileno	Opcionales	Patín cromado



MODELO	ALTO	ANCHO	FONDO	ALTO	ANCHO	FONDO	ALTO	ANCHO	FONDO	ALTO	ANCHO	FONDO	ALTO	ANCHO	FONDO	ALTO	ANCHO	FONDO																	
IOWA 1	82	50	56	IOWA 1 CON BRAZOS	82	58	56	IOWA 6	87	50	56	IOWA 7	86/98	50	56	IOWA 8/9	85	50	56	IOWA G	80/92	50	56	IOWA TF	118	52	52	IOWA TG	85/110	50	56	IOWA P	86	50	54

Altura / Height / Haut

Anchura / Width / Large

Fondo / Depth / Fond

PVP	
MODELO	POLIPROPILENO: Negro, gris, blanco
IOWA 1	92 €
IOWA 6	221 €
IOWA 7	288 €
IOWA 8	190 €
IOWA 9	202 €
IOWA G	136 €
IOWA TF	144 €
IOWA TG	176 €
IOWA P	146 €

DATOS ESPECÍFICOS			
METRAJE	PESO	VOL.	UD.x BULTO
---	4	0,54	5
---	8	0,54	1
---	8	0,54	1
---	8	0,54	1
---	8	0,54	1
---	5,6	0,56	1
---	6	0,6	4
---	8,5	0,56	1
---	7	0,56	4

Silla de colectividades con asiento y respaldo en polipropileno perforado. Diferentes bases disponibles. Brazos opcionales fabricados en polipropileno con refuerzos en acero. Posibilidad de tapizar asiento, unir entre ellas y colocar pala. Silla apilable y transportable mediante carro portasilas.

CODIGO	COMPLEMENTO	P.V.P.
IO-AT	ASIENTO TAPIZADO(GRUPO 1)	+15,00 €
IO-BF	BRAZOS FIJOS	+20,00 €
IO-PA	POLIPROPILENO AMARILLO	+6,00 €
IO-PV	POLIPROPILENO VERDE	+6,00 €
IO-PJ	POLIPROPILENO ZANAHORIA	+6,00 €
IO-PZ	POLIPROPILENO AZUL	+6,00 €

COMPLEMENTOS OPCIONALES		
BRAZOS	ESTRUCTURA	INCREMENTO DEL PRECIO
Juego brazos + pala(indicar dcha o izda)		+70,00 €
Juego Brazos Azul, Amarillo, Verde o Zanahoria		+6,00 €
	Ral 9006/ Blanco (Iowa 1)	+7,00 €
	Cromada (Iowa 1)	+10,00 €
	Iowa G base Blanca	+13,00 €
	Base aluminio pulido para versión giratoria	+41,00 €
	Base Poliamida Piramidal Blanca Iowa 8/9	+25,00 €
	Mecanismo + Pala Modelo Iowa G	+173,00 €
	Carro portasilas	+113,00 €
	Eganche unión	+11,00 €



VERONA 1



VERONA 6 Respaldo Malla  
Asiento Tapizado



VERONA 7 c/brazos  
Asiento Tapizado

VERONA 1 c/brazos  
Asiento y Respaldo Tapizados



VERONA 9 c/brazos Asiento y Respaldo Tapizados



VERONA TF

VERONA G



VERONA P c/brazos  
Asiento y Respaldo Tapizados

**COLORES ESTRUCTURA METÁLICA VERONA 1: negro CON INCREMENTO: blanco, aluminio y cromo**

**COLORES POLIPROPILENO: negro. CON INCREMENTO: amarillo, verde, burdeos, azul y gris**

**COLORES BASE PIRAMIDAL POLIAMIDA: negro. Con incremento: blanco**

MODELO	RESPALDO	ASIENTO	BRAZOS	BASE
VERONA 1	Polipropileno	Polipropileno	Opcionales	4 patas metálicas
VERONA 6	Polipropileno	Polipropileno	Opcionales	4 radios cromada piramidal
VERONA 7	Polipropileno	Polipropileno	Opcionales	5 radios cromada piramidal c/ruedas
VERONA 8	Polipropileno	Polipropileno	Opcionales	4 radios poliamida piramidal negra
VERONA 9	Polipropileno	Polipropileno	Opcionales	4 radios poliamida piramidal negra c/ruedas
VERONA G	Polipropileno	Polipropileno	Opcionales	Poliamida Negra
VERONA TF	Polipropileno	Polipropileno	Opcionales	Taburete Fijo Cromo
VERONA TG	Polipropileno	Polipropileno	Opcionales	Poliamida Negra+ Aro Cromo
VERONA P	Polipropileno	Polipropileno	Opcionales	Patín cromado

**COLORES MALLA: Negro, blanco, burdeos, naranja, verde, visón, gris y melocotón**



VERONA 1	VERONA 1 CON BRAZOS	VERONA 1 RESPALDO MALLA	VERONA 6	VERONA 7	VERONA 8/9	VERONA G	VERONA TF	VERONA TG	VERONA P	
82	82	82	85	84/96	85	80/92	118	85/110	86	Altura / Height / Haut
51	59	51	51	51	51	51	53	51	52	Anchura / Width / Large
53	53	53	53	53	53	53	53	53	54	Fondo / Depth / Fond

PVP	
MODELO	POLIPROPILENO: Negro
VERONA 1	71 €
VERONA 6	201 €
VERONA 7	268 €
VERONA 8	183 €
VERONA 9	195 €
VERONA G	115 €
VERONA TF	129 €
VERONA TG	170 €
VERONA P	126 €

DATOS ESPECÍFICOS			
METRAJE	PESO	VOL.	UD.x BULTO
---	4	0,54	5
---	7	0,54	2
---	7,5	0,54	2
---	7	0,54	2
---	7	0,54	2
---	5,6	0,56	1
---	6	0,56	1
---	8	0,56	1
---	7	0,56	4

Silla de colectividades con asiento y respaldo fabricado en polipropileno reforzado con fibra de vidrio. Posibilidad de tapizar sobre las carcassas plásticas y de realizar el respaldo en malla de diferentes colores. Diferentes bases disponibles. Brazos fijos fabricados en polipropileno con posibilidad de incorporar pala. Silla apilable y transportable en carro portasillas. Disponible unión entre sillas.

CODIGO	COMPLEMENTO	P.V.P.
VE-AT	ASIENTO TAPIZADO(GRUPO 1)	+15,00 €
VE-RM	RESPALDO MALLA	+26,00 €
VE-RT	RESPALDO TAPIZADO	+7,00 €
VE-BF	BRAZOS FIJOS	+16,50 €
VE-PA	POLIPROPILENO BURDEOS	+6,00 €
VE-PV	POLIPROPILENO GRIS	+6,00 €
VE-PB	POLIPROPILENO VERDE	+6,00 €
VE-PG	POLIPROPILENO AMARILLO	+6,00 €
VE-PZ	POLIPROPILENO AZUL	+6,00 €

COMPLEMENTOS OPCIONALES		
BRAZOS	ESTRUCTURA	INCREMENTO DEL PRECIO
Juego Brazos Azul, Amarillo, Verde o Zanahoria		+6,00 €
Ral 9006/ Blanco (Verona 1)		+8,00 €
Cromada (Verona 1)		+10,00 €
Verona G Base Blanca		+13,00 €
Base aluminio pulido para Verona G		+41,00 €
Base Poliamida Piramidal Blanca Verona 8/9		+25,00 €
Mecanismo + Pala Modelo Verona G		+173,00 €
Carro portasillas		+113,00 €
Enganche unión		+11,00 €



FLORIDA 1



FLORIDA 2



FLORIDA 1P c/brazos FLORIDA 2P c/brazos

### DATOS ESPECÍFICOS

MODELO	RESPALDO	ASIENTO	BRAZOS	BASE	METRAJE	PESO	VOL.	UD.x BULTO
FLORIDA 1	Tapizado	Tapizado	Opcionales	4 patas epoxi	0,6	4	0,54	4
FLORIDA 1P	Tapizado	Tapizado	Opcionales	Patín cromado	0,6	7	0,54	4
FLORIDA 2	Malla	Tapizado	Opcionales	4 patas epoxi	0,6	4	0,54	4
FLORIDA 2P	Malla	Tapizado	Opcionales	Patín cromado	0,6	7	0,54	4

COLORES MALLA: negro, blanco, burdeos, azul, naranja, verde, visón, gris y melocotón

COLORES ESTRUCTURA FLORIDA 1 y 2 : blanco y negro  
CON INCREMENTO: cromo

COLORES PLÁSTICO: blanco y negro



FLORIDA 1

82  
52  
50



FLORIDA 2

82  
52  
50



FLORIDA CON BRAZOS

82  
59  
50



FLORIDA P

86  
52  
54

Altura / Height / Haut  
Anchura / Width / Large  
Fondo / Depth / Fond

### PVP POR TAPICERÍAS

MODELO	Grupo 1	Grupo 2	Grupo 3	Piel	T.Cliente
FLORIDA 1	128 €	141 €	156 €	187 €	125 €
FLORIDA 1P	190 €	209 €	230 €	276 €	188 €
FLORIDA 2	137 €	144 €	151 €	166 €	135 €
FLORIDA 2P	200 €	210 €	221 €	243 €	198 €

Serie de colectividades con asiento y respaldo fabricado en poliámidia reforzada con fibra de vidrio. Respaldo tapizado con carcasa plástica en la trasera, o en malla técnica.

Silla apilable y con posibilidad de colocar brazo con pala.

Disponibles uniones entre sillas.

Versión 4 patas metálicas o patín cromado.

### COMPLEMENTOS OPCIONALES

BRAZOS	RESPALDO	ESTRUCTURA	INCREMENTO DEL PRECIO
Juego Brazos Fijos			+29,00 €
Juego Brazos + Pala(indicar dcha o izda)			+76,00 €
	Completamente Tapizado(Florida 1 y 1P)		+26,00 €
		Enganche unión	+11,00 €
		Cromada (Florida 1 y 2)	+10,00 €
		Con Ruedas (Florida 1 y 2)	+50,00 €



### DATOS ESPECÍFICOS

MODELO	ASIENTO / RESPALDO	BRAZOS	BASE	METRAJE	PESO	VOL.	UD.x BULTO
BAHIA	Monocarcasa Polipropileno	-----	4 patas cromadas	---	3,3	0,4	5

COLORES PLASTICO: Negro, blanco, azul, pistacho, rojo



BAHIA

81  
50  
60

Altura / Height / Haut  
Anchura / Width / Large  
Fondo / Depth / Fond

MODELO	P.V.P.
BAHIA	67 €

Silla de colectividades monocarcasa fabricada en polipropileno de varios colores.

Estructura fija de 4 patas en acero cromado de diámetro 20 mm. y grosor 2 mm.

PRAGA 2  
CARCASA PLÁSTICA



### DATOS ESPECÍFICOS

MODELO	RESPALDO	ASIENTO	BRAZOS	BASE	METRAJE	PESO	VOL.	UD.x BULTO
PRAGA 2	Tapizado/Polipropileno	Tapizado	En estructura	4 patas epoxi negro	0,6	7,4	0,56	4

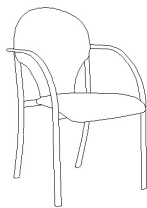

PRAGA 2

83

Altura / Height / Haut

47

Anchura / Width / Large

47

Fondo / Depth / Fond

### PVP POR TAPICERÍAS

MODELO	Grupo 1	Grupo 2	Grupo 3	Piel	T.Cliente
PRAGA 2	95 €	105 €	115 €	138 €	93 €

Silla confidente, respaldo con trasera en polipropileno y asiento tapizado sobre tablero reciclado. Apilables entre ellas.



MÓNACO F



MÓNACO 3



MÓNACO P

### DATOS ESPECÍFICOS

MODELO	RESPALDO	ASIENTO	BRAZOS	BASE	METRAJE	PESO	VOL.	UD.x BULTO
MONACO F	Tapizado	Tapizado	Opcionales	4 patas epoxi negro	0,55	5,45	0,54	5
MONACO 3	Tapizado	Tapizado	En estructura	4 patas epoxi negro	0,55	6,15	0,54	4
MONACO P	Polipropileno	Polipropileno	Opcionales	4 patas epoxi negro	---	4,4	0,54	5



MONACO F

79  
48  
42



MONACO 3

79  
48  
42



MONACO P

79  
48  
42

Altura / Height / Haut

Anchura / Width / Large

Fondo / Depth / Fond

### PVP POR TAPICERÍAS

MODELO	Grupo 1	Grupo 2	Grupo 3	Piel	T.Cliente
MONACO F	69 €	77 €	84 €	101 €	68 €
MONACO 3	87 €	96 €	105 €	125 €	85 €
POLIPROPILENO: Negro, verde, azul, naranja, amarillo, rojo					
MONACO P	54 €				

Silla de colectividades funcional, combina tapizado con polipropileno. Estructura metálica de cuatro patas con tubo oval. Apilables entre ellas.

### COMPLEMENTOS OPCIONALES

BRAZOS	BASE	ESTRUCTURA	INCREMENTO DEL PRECIO
Mónaco Fijos			+32,00 €
Brazo+Pala Mónaco			+46,00 €
Brazo+Pala Madera			+54,00 €
	Parrilla Inferior		+17,00 €
		Pieza unión extensible	+4,50 €
		Pieza unión normal	+2,20 €



# CONTRACT & SOFT SEATING



**BASEL**

**60**



**GLASGOW**

**64**



**TRIPOLI**

**65**



**VENECIA**

**66**



**MEMPHIS**

**67**



**ALBERTA**

**68**



**VANCOUVER**

**70**



**NIZA**

**72**



**COFFE  
TABLES  
NEREO 3**

**73**



BASEL 4R



BASEL 4

### DATOS ESPECÍFICOS

MODELO	RESPALDO	ASIENTO	BASE	ESTRUCTURA	METRAJE	PESO	VOL.	BULTOS
BASEL 5R	Tapizado	Tapizado	DM LACADO ACRÍLICO	CONTRACHAPADO	5,10	48	0,80	2
BASEL 4R	Tapizado	Tapizado	DM LACADO ACRÍLICO	CONTRACHAPADO	4,10	40	0,65	2
BASEL 3R	Tapizado	Tapizado	DM LACADO ACRÍLICO	CONTRACHAPADO	3,10	30	0,50	2
BASEL 2R	Tapizado	Tapizado	DM LACADO ACRÍLICO	CONTRACHAPADO	2,10	22	0,35	2
BASEL 5	-	Tapizado	DM LACADO ACRÍLICO	CONTRACHAPADO	3,60	32	0,75	1
BASEL 4	-	Tapizado	DM LACADO ACRÍLICO	CONTRACHAPADO	2,90	26	0,60	1
BASEL 3	-	Tapizado	DM LACADO ACRÍLICO	CONTRACHAPADO	2,20	20	0,45	1
BASEL 2	-	Tapizado	DM LACADO ACRÍLICO	CONTRACHAPADO	1,50	15	0,30	1

### BASE LACADA INDICAR COLOR PVP POR TAPICERÍAS

MODELO	Grupo 1	Grupo 2	Grupo 3	Piel	T.Cliente
BASEL 5R	1.136 €	1.248 €	1.373 €	1.648 €	1.111 €
BASEL 4R	964 €	1.060 €	1.168 €	1.399 €	944 €
BASEL 3R	793 €	872 €	959 €	1.149 €	776 €
BASEL 2R	666 €	733 €	806 €	967 €	652 €
BASEL 5	770 €	847 €	931 €	1.118 €	754 €
BASEL 4	643 €	707 €	779 €	934 €	629 €
BASEL 3	517 €	569 €	624 €	749 €	506 €
BASEL 2	436 €	480 €	528 €	634 €	427 €
RESP 5	367 €	404 €	443 €	532 €	360 €
RESP 4	321 €	353 €	388 €	465 €	315 €
RESP 3	275 €	303 €	333 €	399 €	270 €
RESP 2	228 €	251 €	276 €	331 €	223 €

Banco de espera con asiento y respaldo fabricado en contrachapado con espuma de densidad 40 y tapizados en cualquier tejido de nuestro catálogo.

Estructura formada por dos patas y dos vigas de DM lacado en blanco o en negro.

Respaldo fijado al asiento en cualquier posición mediante pletinas de sujeción metálicas acabadas a juego con la estructura.

Posibilidad de incorporar giros, extensiones y uniones para formar diferentes conjuntos. Pueden electrificarse con los diferentes accesorios eléctricos de ISMOBEL.

Armario auxiliar para enfrentar diferentes bancos, con la posibilidad de incorporar separadores de diferentes materiales y electrificar según las necesidades.

**TODAS LAS REFERENCIAS SE SUMINISTRAN DESMONTADAS**

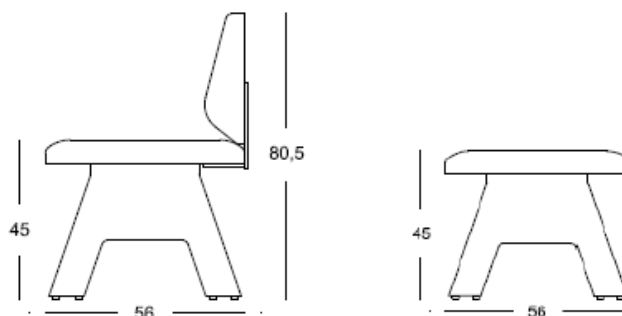
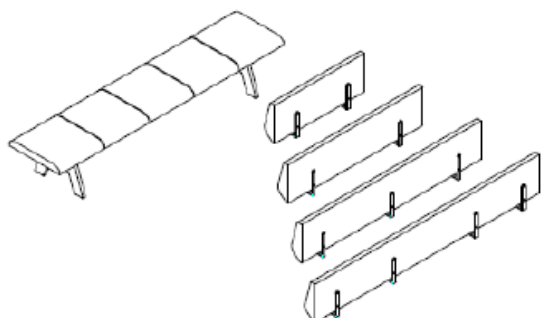

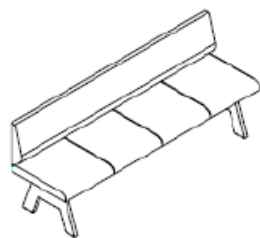
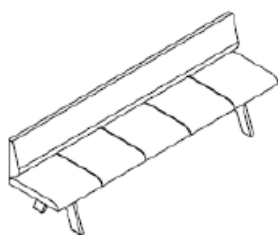

**BASEL 5R**

**BASEL 4R**

**BASEL 3R**

**BASEL 2R**

81  
250  
56

81  
200  
56

81  
150  
56

81  
100  
56

Altura / Height / Haut  
Anchura / Width / Large  
Fondo / Depth / Fond

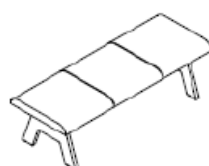
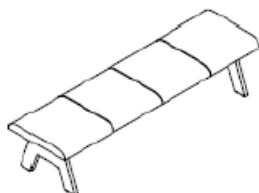
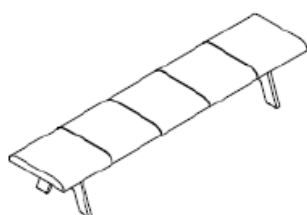

**BASEL 5**

**BASEL 4**

**BASEL 3**

**BASEL 2**

45  
250  
56

45  
200  
56

45  
150  
56

45  
100  
56

Altura / Height / Haut  
Anchura / Width / Large  
Fondo / Depth / Fond

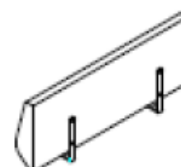
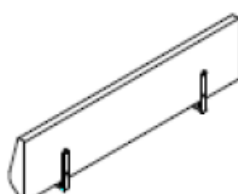
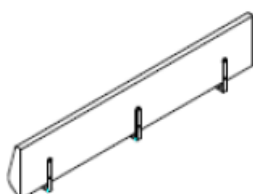
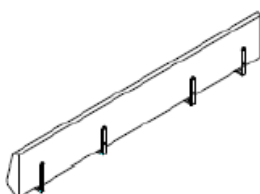

**RESPALDO BASEL 5**

**RESPALDO BASEL 4**

**RESPALDO BASEL 3**

**RESPALDO BASEL 2**

37  
250  
12

37  
200  
12

37  
150  
12

37  
100  
12

Altura / Height / Haut  
Anchura / Width / Large  
Fondo / Depth / Fond

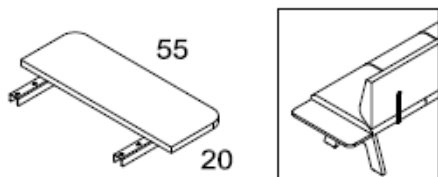

MESA LATERAL (INDICAR LADO)	
MODELO	MELAMINA ISMOBEL
MESA 1	67 €

NO INCLUYE ELECTRIFICACIÓN  
VER ACCESORIOS TARIFA ISMOBEL

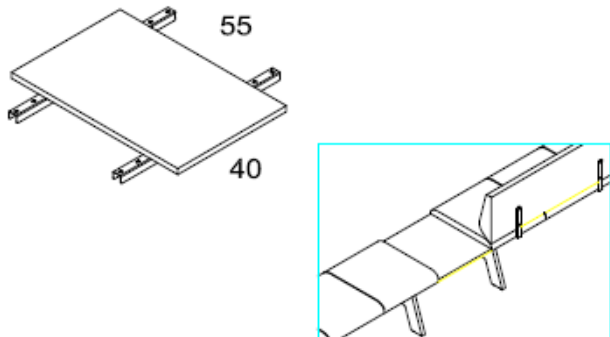

MESA UNIÓN 2 BANCOS	
MODELO	MELAMINA ISMOBEL
MESA 2	123 €

NO INCLUYE ELECTRIFICACIÓN  
VER ACCESORIOS TARIFA ISMOBEL

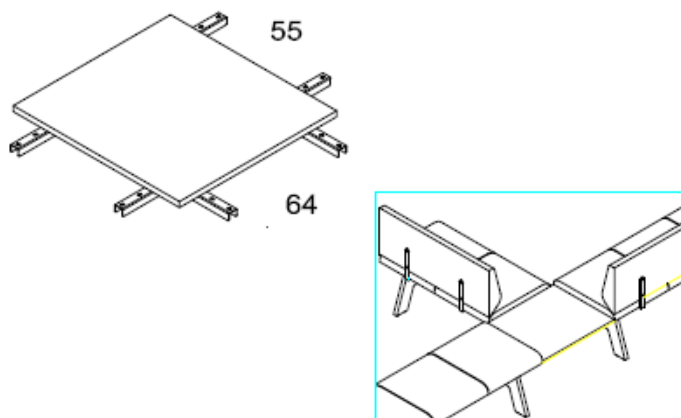

MESA UNIÓN 3 BANCOS	
MODELO	MELAMINA ISMOBEL
MESA 3	169 €

NO INCLUYE ELECTRIFICACIÓN  
VER ACCESORIOS TARIFA ISMOBEL

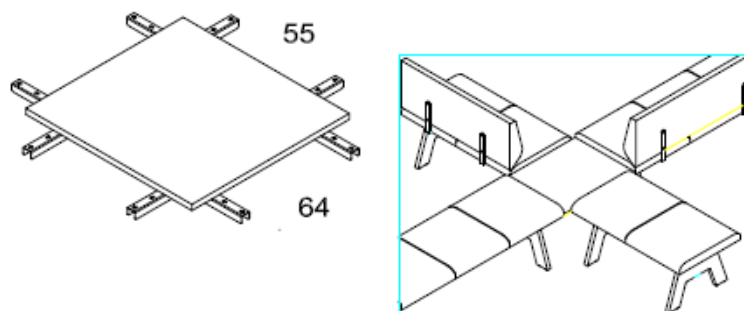

MESA UNIÓN 4 BANCOS	
MODELO	MELAMINA ISMOBEL
MESA 4	214 €

NO INCLUYE ELECTRIFICACIÓN  
VER ACCESORIOS TARIFA ISMOBEL

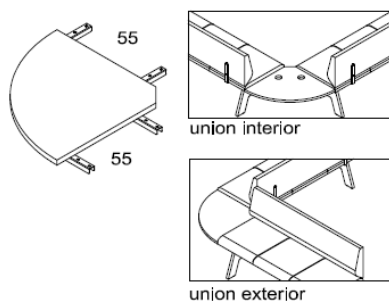

ANGULO UNIÓN 2 BANCOS 90°	
MODELO	MELAMINA ISMOBEL
MESA 5	169 €

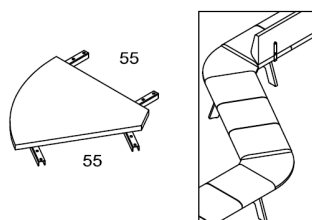

ANGULO UNIÓN 2 BANCOS 60°	
MODELO	MELAMINA ISMOBEL
MESA 6	157 €

NO INCLUYE ELECTRIFICACIÓN  
VER ACCESORIOS TARIFA ISMOBEL

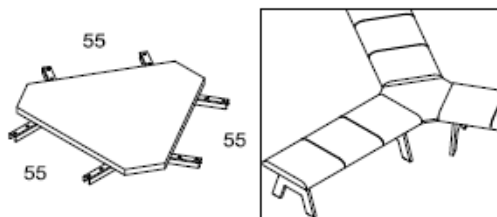

### ANGULO UNIÓN 3 BANCOS 120°

MODELO	MELAMINA ISMOBEL
MESA 7	224 €

NO INCLUYE ELECTRIFICACIÓN  
VER ACCESORIOS TARIFA ISMOBEL

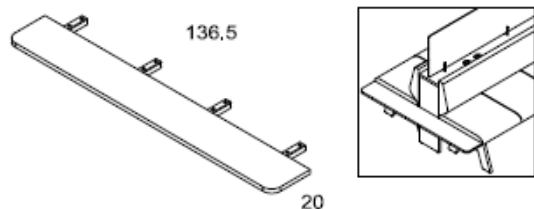

### MESA LATERAL 2 BANCOS ENFRENTADOS

MODELO	MELAMINA ISMOBEL
MESA 8	147 €

NO INCLUYE ELECTRIFICACIÓN  
VER ACCESORIOS TARIFA ISMOBEL

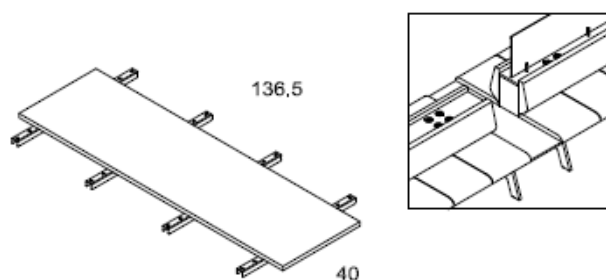

### MESA UNIÓN 4 BANCOS ENFRENTADOS

MODELO	MELAMINA ISMOBEL
MESA 9	282 €

NO INCLUYE ELECTRIFICACIÓN  
VER ACCESORIOS TARIFA ISMOBEL

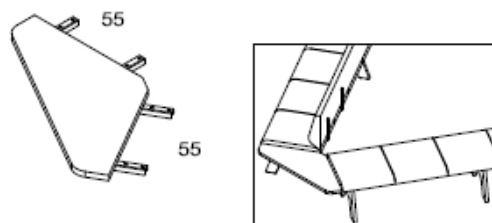

### ANGULO UNIÓN 120° DOS BANCOS

MODELO	MELAMINA ISMOBEL
MESA 10	169 €

NO INCLUYE ELECTRIFICACIÓN  
VER ACCESORIOS TARIFA ISMOBEL

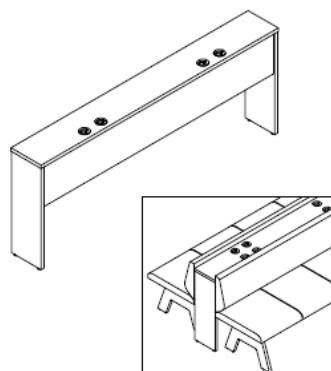

### MUEBLE ENFRENTADO

MODELO	MELAMINA ISMOBEL
ARM 5	169 €
ARM 4	147 €
ARM 3	123 €
ARM 2	102 €

NO INCLUYE ELECTRIFICACIÓN  
VER ACCESORIOS TARIFA ISMOBEL

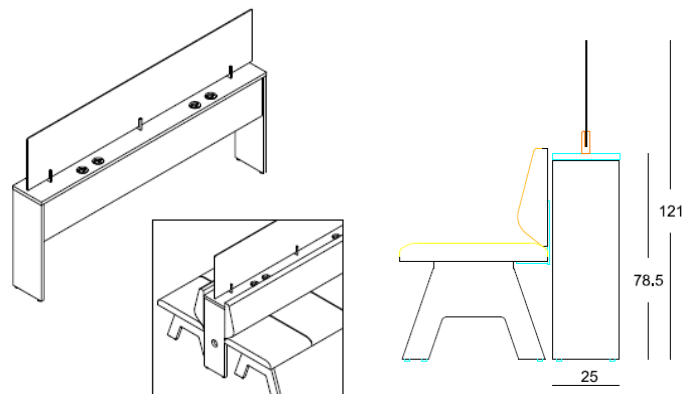

### MUEBLE ENFRENTADO CON SEPARADOR

MODELO	MELAMINA ISMOBEL	METACRILATO TRANSLÚCIDO
ARM SEP5	315 €	485 €
ARM SEP4	248 €	405 €
ARM SEP3	214 €	350 €
ARM SEP2	180 €	305 €

NO INCLUYE ELECTRIFICACIÓN  
VER ACCESORIOS TARIFA ISMOBEL



GLASGOW 1



GLASGOW 3



GLASGOW MM / MC (Cristal)

### DATOS ESPECÍFICOS

MODELO	RESPALDO	ASIENTO	ESTRUCTURA	BRAZOS	BASE	METRAJE	PESO	VOL.	UD.x BULTO
GLASGOW 1	Tapizado	Tapizado	Metálica	Tapizados/Metálicos	Metálica Negro	3,6	37,55	0,5	1
GLASGOW 3	Tapizado	Tapizado	Metálica	Tapizados/Metálicos	Metálica Negro	7,55	75,25	1,2	1

### COLOR GLASGOW MM

Gris	Cerezo	Haya	Grafito	Baco
Blanco	Roble	Arce	Teka	Aluminio

CONSULTAR OTROS COLORES ESTRUCTURA

MODELO	TAPA	ESTRUCTURA
GLASGOW MM	Melamina 19 mm.	Metálica Negro
GLASGOW MC	Cristal Seg. Mate 3+3	Metálica Negro



GLASGOW 1  
82  
90  
74

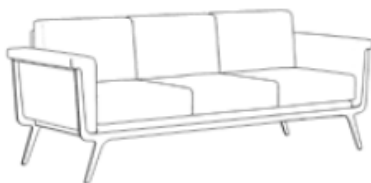

GLASGOW 3  
82  
208  
74



MESA GLASGOW  
43  
98  
62  
Altura / Height / Haut  
Anchura / Width / Large  
Fondo / Depth / Fond

### PVP POR TAPICERÍAS

MODELO	Grupo 1	Grupo 2	Grupo 3	Piel	T.Cliente
GLASGOW 1	599 €	659 €	726 €	908 €	588 €
GLASGOW 3	1095 €	1203 €	1325 €	1656 €	1073 €

### MESAS

GLASGOW MM	323 €
GLASGOW MC	490 €

Sofá de recepción de 1 ó 3 plazas. Estructura metálica sobre la que se apoya la base y el respaldo de madera completamente tapizado. Brazos y cojines tapizados sobre espuma de corte de alta resistencia. Existe la posibilidad de incorporar mesas de centro en madera o cristal.



TRIPOLI 2

TRIPOLI MM



TRIPOLI MC

TRIPOLI 1

### DATOS ESPECÍFICOS

MODELO	RESPALDO	ASIENTO	ESTRUCTURA	BRAZOS	BASE	METRAJE	PESO	VOL.	UD.x BULTO
TRIPOLI 1	Tapizado	Tapizado	Contrachapado Haya	---	Patin Cromado	1,5	18	0,6	1
TRIPOLI 2	Tapizado	Tapizado	Contrachapado Haya	---	4 Patas Madera	1,5	19	0,6	1

### COLOR TRIPOLI MM

Gris	Cerezo	Haya	Grafito	Baco
Blanco	Roble	Arce	Teka	Aluminio

MODELO	TAPA	ESTRUCTURA
TRIPOLI MM	Melamina 19 mm.	Varilla Cromada
TRIPOLI MC	Cristal Seg. Mate 3+3	Varilla Cromada



TRIPOLI 1

75

65

76



TRIPOLI 2

75

65

76



MESA TRIPOLI

40

70

50

Altura / Height / Haut

Anchura / Width / Large

Fondo / Depth / Fond

### PVP POR TAPICERÍAS

MODELO	Grupo 1	Grupo 2	Grupo 3	Piel	T.Cliente
TRIPOLI 1	316 €	348 €	382 €	478 €	310 €
TRIPOLI 2	404 €	444 €	488 €	610 €	396 €

### MESAS

TRIPOLI MM	262 €
TRIPOLI MC	404 €

Sillón de recepción formado por una monocarcasa de madera conformada completamente tapizada. Estructura de tubo de acero cromado diámetro 26 mm. Incorpora mesa de centro fabricada en varilla cromada y tapa en cristal de seguridad o madera.

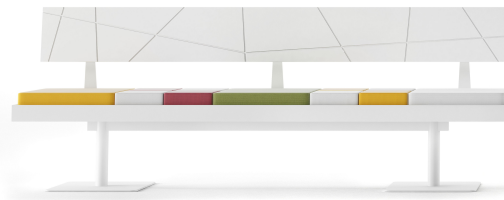

### DATOS ESPECÍFICOS

MODELO	RESPALDO	ASIENTO	ESTRUCTURA	METRAJE	PESO	VOL.	UD.x BULTO
VENECIA 3	Lacado	Tapizado	Peana de acero blanca	2,4	30	0,7	1
VENECIA 4	Lacado	Tapizado	Peana de acero blanca	2,7	40	0,9	1
VENECIA 5	Lacado	Tapizado	Peana de acero blanca	3	50	1,2	1

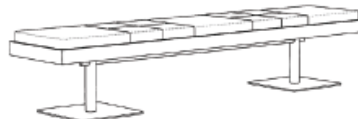
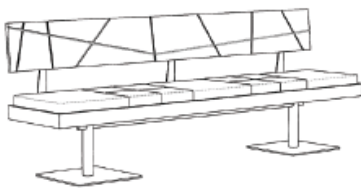

VENECIA C/RESPALDO

90  
150/195/245  
52

VENECIA

50  
150/195/245  
52

Altura / Height / Haut  
Anchura / Width / Large  
Fondo / Depth / Fond

### TAPIZADO GOYA

MODELO	P.V.P.	
	CON RESPALDO	SIN RESPALDO
VENECIA 3	1.011 €	840 €
VENECIA 4	1.115 €	920 €
VENECIA 5	1.237 €	1.011 €

Los precios incluyen 1 cojín grande por puesto

Banco de espera con asiento fabricado en madera y MDF lacado, con cojines de espuma densidad 40 tapizados en terminado Goya e intercambiables entre sí.

Respaldo en DM lacado, estructura en acero pintado tanto en respaldo como en asiento.

Posibilidad de incorporar respaldo.

Estructura metálica en color blanco.

### COMPLEMENTOS OPCIONALES

COJINES	INCREMENTO DEL PRECIO
Dividir cojín en 2 partes(precio por puesto)	+31,00 €
Dividir cojín en 4 partes(precio por puesto)	+62,00 €
Tapizado Grupo 2	+15%
Tapizado Grupo 3	+20%



MEMPHIS



MEMPHIS CP

### DATOS ESPECÍFICOS

MODELO	RESPALDO	ASIENTO	BRAZOS	BASE	METRAJE	PESO	VOL.	UD.x BULTO
MEMPHIS	Tapizado	Tapizado	Opcionales	4 patas epoxi negro	1,4	13,9	0,56	1

### MESAS

MODELO	TAPA	ESTRUCTURA	BASE
MEMPHIS MP	Melamina	Metálica	Cuadro metálico curvado
MEMPHIS CP	Cristal fume 6 mm	Metálica	Cuadro metálico curvado

COLOR ESTRUCTURA Y BRAZOS: negro. CON INCREMENTO: blanco(solo sillón)



MEMPHIS

75  
65  
76



MESA MEMPHIS

33  
60  
53

Altura / Height / Haut

Anchura / Width / Large

Fondo / Depth / Fond

### PVP POR TAPICERÍAS

MODELO	Grupo 1	Grupo 2	Grupo 3	Piel	T.Cliente
MEMPHIS	243 €	267 €	294 €	353 €	238 €
	<b>MESAS</b>				
MEMPHIS MP	126 €				
MEMPHIS CP	158 €				

Módulo de recepción con estructura metálica e inyectado en espuma de alta densidad indeformable, sobre estructura de hierro con 4 patas de tubo. Mesas de tubo curvado con topes antideslizamiento.

### COMPLEMENTOS OPCIONALES

BRAZOS	BASE	VARIOS	INCREMENTO DEL PRECIO
Juego Brazos Negros			+83,00 €
Juego Brazos Blancos			+95,00 €
	Color blanco(sillón)		+13,00 €
		Pieza de unión	+17,00 €



ALBERTA M



MODELO	RESPALDO	ASIENTO	ESTRUCTURA	BRAZOS	BASE	DATOS ESPECÍFICOS			
						METRAJE	PESO	VOL.	UD.x BULTO
ALBERTA 1	Tapizado	Tapizado	Metálico/Madera	Incluidos	4 patas cromadas	1,8	7	0,45	1
ALBERTA 2	Tapizado	Tapizado	Metálico/Madera	Incluidos	4 patas madera	1,8	7,5	0,45	1
ALBERTA 3	Tapizado	Tapizado	Metálico/Madera	Incluidos	Piramidal Poliamida Negra	1,8	8	0,45	1
ALBERTA 4	Tapizado	Tapizado	Metálico/Madera	Incluidos	4 radios cromada piramidal	1,8	10,5	0,45	1
ALBERTA 5	Tapizado	Tapizado	Metálico/Madera	Incluidos	5 radios cromada piramidal c/ruedas	1,8	11	0,45	1
ALBERTA M	Mesa Redonda 19 mm. de espesor. Diámetro 60 cm. Con 4 patas de madera					---	15	0,06	1



ALBERTA 1	ALBERTA 2	ALBERTA 3	ALBERTA 4	ALBERTA 5	ALBERTA M	
80	80	80	80	80	42	Altura / Height / Haut
50	50	50	50	50	60	Anchura / Width / Large
50	50	50	50	50	60	Fondo / Depth / Fond

### PVP POR TAPICERÍAS

MODELO	Grupo 1	Grupo 2	Grupo 3	Piel	T.Cliente
ALBERTA 1	238 €	262 €	288 €	344 €	233 €
ALBERTA 2	315 €	347 €	381 €	457 €	309 €
ALBERTA 3	297 €	326 €	359 €	432 €	291 €
ALBERTA 4	334 €	367 €	403 €	487 €	329 €
ALBERTA 5	386 €	425 €	467 €	563 €	380 €

### MESAS

ALBERTA M	195 €				
-----------	-------	--	--	--	--

Sillón para contract con estructura de madera contrachapada con inyección de espuma.  
Brazos estructurales y base de 4 patas en acero cromado o distintas bases opcionales.

### COMPLEMENTOS OPCIONALES

BASE	INCREMENTO DEL PRECIO
Alberta 3 con ruedas	+12,00 €
Base Poliamida Piramidal Blanca Alberta 3	+25,00 €

VANCOUVER 1



VANCOUVER PP

VANCOUVER 2



VANCOUVER 5B



VANCOUVER 3B

VANCOUVER 4B

### DATOS ESPECÍFICOS

MODELO	SOBRE	BASE	METRAJE	PESO	VOL.	BULTOS
VANCOUVER 1B	Cuadrado Melamina 19 mm./Fenólico Blanco 60x60 cm	Aluminio Pulido altura 45 cm	---	10	0,03	3
VANCOUVER 1M	Cuadrado Melamina 19 mm./Fenólico Blanco 80x80 cm	Aluminio Pulido altura 73 cm	---	15	0,04	3
VANCOUVER 1A	Cuadrado Melamina 19 mm./Fenólico Blanco 60x60 cm	Aluminio Pulido altura 110 cm	---	15	0,05	3
VANCOUVER 2B	Cuadrado Melamina 19 mm./Fenólico Blanco 60x60 cm	Cromada altura 45 cm	---	20	0,03	3
VANCOUVER 2M	Cuadrado Melamina 19 mm./Fenólico Blanco 80x80 cm	Cromada altura 73 cm	---	25	0,04	3
VANCOUVER 2A	Cuadrado Melamina 19 mm./Fenólico Blanco 60x60 cm	Cromada altura 110 cm	---	25	0,05	3
VANCOUVER 3B	Cuadrado Melamina 19 mm. 60x60 cm	Altura 45 cm	---	20	0,05	2
VANCOUVER 4B	Ovalada Melamina 19 mm. 70x52 cm	Altura 45 cm	---	25	0,05	2
VANCOUVER 5B	Rectangular Ovalada Melamina 19 mm. 120x40 cm	Altura 45 cm	---	30	0,05	2
VANCOUVER PP	Puff Tapizado	Fija	1	4	0,07	1
VANCOUVER PG	Puff Tapizado	Fija	1,1	5	0,08	1

Serie de mesas bajas, medias o altas con diferentes estructuras cromadas y encimeras en diferentes acabados. Puff tapizados.



**VANCOUVER 1**

47 / 73 / 110

60 / 80 / 60

60 / 80 / 60

**VANCOUVER 2**

47 / 73 / 110

60 / 80 / 60

60 / 80 / 60

**VANCOUVER 3**

45

60

60

**VANCOUVER 4**

45

70

52

**VANCOUVER 5**

45

120

40

**VANCOUVER PUFF**

37 / 47

40

40

Altura / Height / Haut

Anchura / Width / Large

Fondo / Depth / Fond

### PVP

MODELO	MELAMINA	FENOLICO BLANCO
VANCOUVER 1B	260 €	285 €
VANCOUVER 1M	302 €	344 €
VANCOUVER 1A	313 €	338 €
VANCOUVER 2B	297 €	320 €
VANCOUVER 2M	338 €	380 €
VANCOUVER 2A	333 €	356 €
<b>MELAMINA</b>		
VANCOUVER 3B	195 €	
VANCOUVER 4B	200 €	
VANCOUVER 5B	225 €	

### SOBRE DE MESAS POSIBILIDAD DE FABRICAR EN:

1. LACA O MADERA BARNIZADA

2. OTRAS MEDIDAS Y FORMAS

CONSULTAR PRECIOS

### COLORES MELAMINA:

ACABADOS ISMOBEL

### COLORES ESTRUCTURA MESAS 3, 4 y 5:

Blanco o Negro

### PVP POR TAPICERÍAS

MODELO	Grupo 1	Grupo 2	Grupo 3	Piel	T.Cliente
VANCOUVER PP	180 €	198 €	218 €	261 €	177 €
VANCOUVER PG	191 €	210 €	232 €	278 €	188 €

### COMPLEMENTOS OPCIONALES

SOBRE DE MESAS	BASE DE PUFF	INCREMENTO DEL PRECIO
Sobre Redondo ( 1 y 2)		+25,00 €
	Con Ruedas (PP y PG)	+42,00 €



### DATOS ESPECÍFICOS

MODELO	RESPALDO	ASIENTO	ESTRUCTURA	BRAZOS	BASE	METRAJE	PESO	VOL.	UD.x BULTO
NIZA 2	Madera	Madera	Chapa Acero	Opcionales	2 patas epoxi aluminio	--	20	0,6	1
NIZA 3	Madera	Madera	Chapa Acero	Opcionales	2 patas epoxi aluminio	--	26,5	0,9	1
NIZA 4	Madera	Madera	Chapa Acero	Opcionales	2 patas epoxi aluminio	--	32,9	1,2	1

DISPONIBLE EN ACABADO FENOLICO. CONSULTAR PRECIOS Y PLAZOS DE ENTREGA

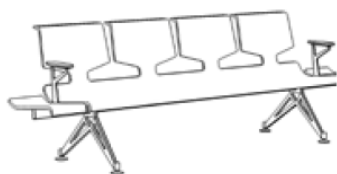

## HASTA FIN DE EXISTENCIAS

NIZA 2	NIZA 3	NIZA 4
82	82	82
105	158	210
65	65	65

Altura / Height / Haut  
Anchura / Width / Large  
Fondo / Depth / Fond

### MADERA P.V.P.

MODELO	BARNIZ NATURAL
NIZA 2	748 €
NIZA 3	1.083 €
NIZA 4	1.367 €

Banco monocarcasa fabricado en contrachapado de haya de 15 mm. de espesor. Posibilidad de barnizar o lacar en cualquier tono. Patas con niveladores y travesaño fabricados en chapa de acero; acabado epoxi color aluminio. Puede incorporar brazos y mesas en los mismos acabados.

### COMPLEMENTOS OPCIONALES

	BARNIZ NATURAL	BARNIZ OTRO TONO	LACADO
BANCADA NIZA 2, 3 y 4	ver tabla P.V.P.	+ 6%	+ 15%
JUEGO BRAZOS	+222 €	+ 6%	+ 15%
MESA	+146 €	+ 6%	+ 15%

# COFFEE TABLES NEREO 3

CONTRACT & SOFT SEATING

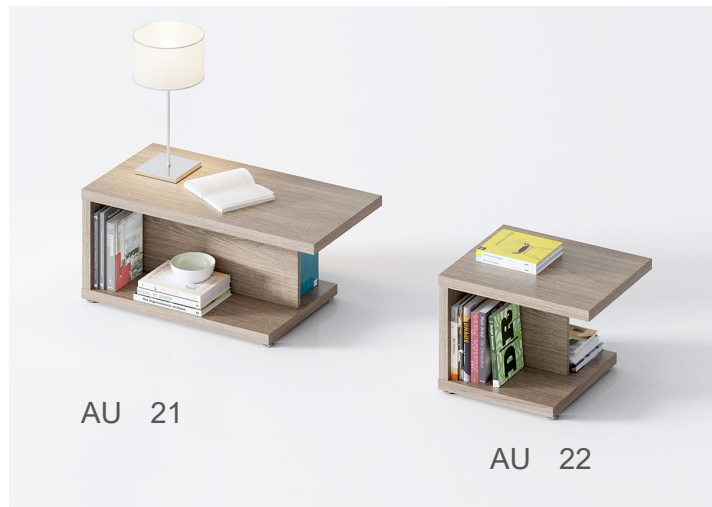

MODELO	ESTRUCTURA	A x B	DATOS ESPECIFICOS			
			ALTURA	PESO	VOL.	BULTOSxUD
J-AUX 11	Melamina 40 mm. c/Niveladores	100x50	42	40	0,10	2
J-AUX 12	Melamina 40 mm. c/Niveladores	60x50	42	35	0,08	2
J-AUX 21	Melamina 40 mm. c/Niveladores	100x50	42	35	0,10	2
J-AUX 22	Melmaina 40 mm. c/Niveladores	60x50	42	30	0,08	2

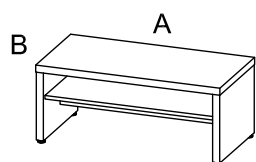

AU 11

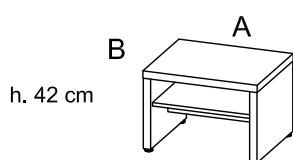

AU 12

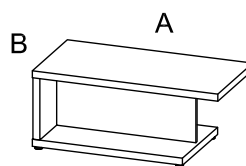

AU 21

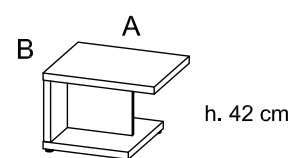

AU 22

COLOR MELAMINA ENCIMERAS Y COSTADOS : blanco, roble y baco.

COLOR MELAMINA RESTO ESTRUCTURA : blanco, roble, baco, gris, cerezo, haya, arce, grafito, aluminio y negro.

	P.V.P. MESAS
J-AUX 11	271 €
J-AUX 12	239 €
J-AUX 21	313 €
J-AUX 22	286 €



# BANCADAS



YALTA PLÁSTICA 76



YALTA TAPIZADA 77



YALTA ASIENTO TAPIZADO 78



YALTA MADERA 79



FRESNO 80



IOWA 82



JAMAICA 84



VIENA 86



LORCA 87



### DATOS ESPECÍFICOS

MODELO	RESPALDO-ASIENTO	MECANISMO	BASE	METRAJE	PESO	VOL.	UD.x BULTO
YALTA PB2	Monocarcasa Polipropileno	Fijo	Patas Poliamida Negra				
YALTA PB3	Monocarcasa Polipropileno	Fijo	Patas Poliamida Negra				
YALTA PB4	Monocarcasa Polipropileno	Fijo	Patas Poliamida Negra				
YALTA PB5	Monocarcasa Polipropileno	Fijo	Patas Poliamida Negra				
YALTA PB2+1	Monocarcasa Polipropileno	Fijo	Patas Poliamida Negra				
YALTA PB3+1	Monocarcasa Polipropileno	Fijo	Patas Poliamida Negra				
YALTA PB4+1	Monocarcasa Polipropileno	Fijo	Patas Poliamida Negra				

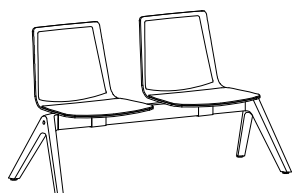

Patas Poliamida Negra

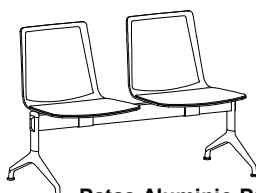

Patas Aluminio Pulido

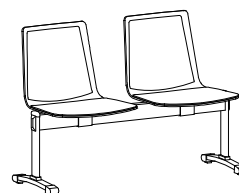

Patas Cromadas

**COLORES POLIPROPILENO: Negro, Blanco  
Gris, Curry, Azul, Terracota y Verde**

### POLIPROPILENO

MODELO	P.V.P.
YALTA PB2	252€
YALTA PB3	328 €
YALTA PB4	414 €
YALTA PB5	490 €
YALTA PB2+1	307 €
YALTA PB3+1	388 €
YALTA PB4+1	467 €

YALTA P

83

Altura / Height / Haut

130/205/270/315

Anchura / Width / Large

60

Fondo / Depth / Fond

### POSIBILIDADES DE TAPIZADO (precio por puesto)

	GRUPO 1	GRUPO 2	GRUPO 3	PIEL	T.CLIENTE
Galleta Tapizada	25 €	28 €	31 €	39 €	24 €
Totalmente tapizada	38 €	42 €	46 €	58 €	37 €

### COMPLEMENTOS OPCIONALES

PATAS	BRAZOS	INCREMENTO DEL PRECIO
Aluminio Pulido		+47,00 €
Cromadas		+25,00 €
	J.Brazos Negros	+50,00 €

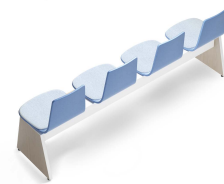

### DATOS ESPECÍFICOS

MODELO	RESPALDO	ASIENTO	MECANISMO	BASE	METRAJE	PESO	VOL.	UD.x BULTO
YALTA B2T+1	Tapizado	Tapizado	Fijo	Banco Melamina				
YALTA B3T	Tapizado	Tapizado	Fijo	Banco Melamina				
YALTA B3T+1	Tapizado	Tapizado	Fijo	Banco Melamina				
YALTA B4T	Tapizado	Tapizado	Fijo	Banco Melamina				

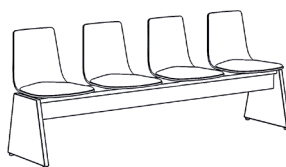

#### YALTA BANCADA 3/4 PUESTOS

83	Altura / Height / Haut
160/215	Anchura / Width / Large
56	Fondo / Depth / Fond
48	Altura asientos / Seat height / Hauteur siège
-	Altura brazos / Arms height / Hauteur accoudoirs
47	Anchura Asiento / Seat width / Largeur d'assise
33	Anchura Respaldo / Backrest Width / Largeur dossier

**TODAS LAS REFERENCIAS SE SUMINISTRAN DESMONTADAS**

#### PVP POR TAPICERÍAS

MODELO	Grupo 1	Grupo 2	Grupo 3	Piel	T.Cliente
YALTA B2T+1	388 €	427 €	469 €	562 €	385 €
YALTA B3T	407 €	448 €	492 €	591 €	403 €
YALTA B3T+1	479 €	527 €	580 €	696 €	474 €
YALTA B4T	497 €	548 €	601 €	722 €	492 €



Carcasa totalmente tapizada

#### ESTRUCTURA BANCADA

\*COLORES MELAMINA: BLANCO, GRIS, GRAFITO,  
ALUMINIO, HAYA, BACO, CEREZO, TEKA, ARCE, ROBLE  
\* CANTEADO BLANCO POR DEFECTO

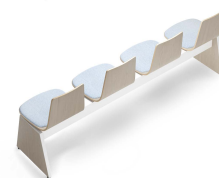

### DATOS ESPECÍFICOS

MODELO	RESPALDO	ASIENTO	MECANISMO	BASE	DATOS ESPECÍFICOS			
					METRAJE	PESO	VOL.	UD.x BULTO
YALTA B2MT+1	Madera	Tapizado	Fijo	Banco Melamina				
YALTA B3MT	Madera	Tapizado	Fijo	Banco Melamina				
YALTA B3MT+1	Madera	Tapizado	Fijo	Banco Melamina				
YALTA B4MT	Madera	Tapizado	Fijo	Banco Melamina				

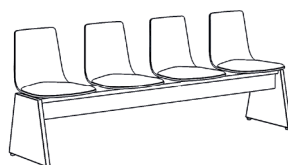

#### YALTA BANCADA 3/4 PUESTOS

83	Altura / Height / Haut
160/215	Anchura / Width / Large
56	Fondo / Depth / Fond
48	Altura asientos / Seat height / Hauteur siège
-	Altura brazos / Arms height / Hauteur accudors
47	Anchura Asiento / Seat width / Largeur d'assise
33	Anchura Respaldo / Backrest Width / Largeur dossier

**TODAS LAS REFERENCIAS SE SUMINISTRAN DESMONTADAS**

#### PVP POR TAPICERÍAS

MODELO	Grupo 1	Grupo 2	Grupo 3	Piel	T.Cliente
YALTA B2MT+1	454 €	477 €	501 €	576 €	450 €
YALTA B3MT	506 €	531 €	557 €	641 €	501 €
YALTA B3MT+1	578 €	607 €	637 €	733 €	571 €
YALTA B4MT	629 €	661 €	694 €	798 €	623 €



Carcasa de madera barnizada con asiento tapizado

#### ESTRUCTURA BANCADA

\*COLORES MELAMINA: BLANCO, GRIS, GRAFITO, ALUMINIO, HAYA, BACO, CEREZO, TEKA, ARCE, ROBLE

\* CANTEADO BLANCO POR DEFECTO



### DATOS ESPECÍFICOS

MODELO	RESPALDO	ASIENTO	MECANISMO	BASE	METRAJE	PESO	VOL.	UD.x BULTO
YALTA B2M+1	Madera	Madera	Fijo	Banco Melamina				
YALTA B3M	Madera	Madera	Fijo	Banco Melamina				
YALTA B3M+1	Madera	Madera	Fijo	Banco Melamina				
YALTA B4M	Madera	Madera	Fijo	Banco Melamina				

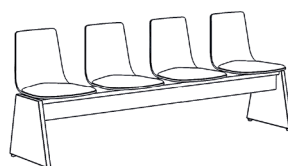

#### YALTA BANCADA 3/4 PUESTOS

83	Altura / Height / Haut
160/215	Anchura / Width / Large
56	Fondo / Depth / Fond
48	Altura asientos / Seat height / Hauteur siège
-	Altura brazos / Arms height / Hauteur accoudoirs
47	Anchura Asiento / Seat width / Largeur d'assise
33	Anchura Respaldo / Backrest Width / Largeur dossier

## TODAS LAS REFERENCIAS SE SUMINISTRAN DESMONTADAS

MODELO	MADERA DE HAYA	P.V.P.
	BARNIZ NATURAL	
YALTA B2M+1		396 €
YALTA B3M		419 €
YALTA B3M+1		491 €
YALTA B4M		513 €



Carcasa de madera barnizada

### ESTRUCTURA BANCADA

\*COLORES MELAMINA: BLANCO, GRIS, GRAFITO, ALUMINIO, HAYA, BACO, CEREZO, TEKA, ARCE, ROBLE

\* CANTEADO BLANCO POR DEFECTO

### COMPLEMENTOS OPCIONALES

CARCASA	INCREMENTO DEL PRECIO
Barniz Otra Tonalidad	+16,00 € / Puesto
Terminación Laca	+48,00 € / Puesto



MODELO	RESPALDO	ASIENTO	MECANISMO	BRAZOS	BASE
FRESNO V2	Polipropileno	Tapizado	Fijo	Opcionales	2 patas poliamida negra
FRESNO V2+1	Polipropileno	Tapizado	Fijo	Opcionales	2 patas poliamida negra
FRESNO V3	Polipropileno	Tapizado	Fijo	Opcionales	2 patas poliamida negra
FRESNO V3+1	Polipropileno	Tapizado	Fijo	Opcionales	2 patas poliamida negra
FRESNO V4	Polipropileno	Tapizado	Fijo	Opcionales	2 patas poliamida negra
FRESNO V4+1	Polipropileno	Tapizado	Fijo	Opcionales	2 patas poliamida negra
FRESNO V5	Polipropileno	Tapizado	Fijo	Opcionales	2 patas poliamida negra
FRESNO VP2	Polipropileno	Polipropileno	Fijo	Opcionales	2 patas poliamida negra
FRESNO VP2+1	Polipropileno	Polipropileno	Fijo	Opcionales	2 patas poliamida negra
FRESNO VP3	Polipropileno	Polipropileno	Fijo	Opcionales	2 patas poliamida negra
FRESNO VP3+1	Polipropileno	Polipropileno	Fijo	Opcionales	2 patas poliamida negra
FRESNO VP4	Polipropileno	Polipropileno	Fijo	Opcionales	2 patas poliamida negra
FRESNO VP4+1	Polipropileno	Polipropileno	Fijo	Opcionales	2 patas poliamida negra
FRESNO VP5	Polipropileno	Polipropileno	Fijo	Opcionales	2 patas poliamida negra

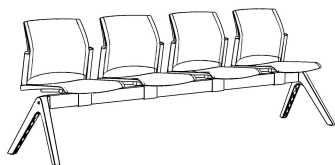

## FRESNO

82  
130/205/270/315  
60

Altura / Height / Haut

Anchura / Width / Large

Fondo / Depth / Fond

### PVP POR TAPICERÍAS

MODELO	Grupo 1	Grupo 2	Grupo 3	Piel	T.Cliente
FRESNO V2	325 €	341 €	359 €	413 €	322 €
FRESNO V2+1	390 €	410 €	429 €	494 €	386 €
FRESNO V3	448 €	470 €	494 €	568 €	444 €
FRESNO V3+1	513 €	539 €	566 €	650 €	508 €
FRESNO V4	574 €	603 €	633 €	728 €	568 €
FRESNO V4+1	639 €	671 €	704 €	810 €	633 €
FRESNO V5	690 €	725 €	760 €	875 €	683 €
POLIPROPILENO: Negro, Gris, Blanco					
FRESNO VP2	295 €				
FRESNO VP2+1	360 €				
FRESNO VP3	403 €				
FRESNO VP3+1	468 €				
FRESNO VP4	514 €				
FRESNO VP4+1	579 €				
FRESNO VP5	615 €				

### DATOS ESPECÍFICOS

METRAJE	PESO	VOL.	UD.x BULTO
1,3	17,8	0,4	1
1,3	24,2	0,57	1
1,8	23,9	0,57	1
1,8	29,65	0,75	1
2	29,65	0,75	1
2	36	0,95	1
2,6	35,75	0,95	1
---	16,6	0,4	1
---	23	0,57	1
---	22,7	0,57	1
---	28,7	0,75	1
---	28,45	0,75	1
---	34,85	0,95	1
---	34,55	0,95	1

Bancada con patas en forma de V fabricadas en poliamida negra. Las patas incorporan niveladores y se unen a través de una viga donde se sujeta la estructura de la silla. Asientos y respaldos fabricados en poliamida o tapizados. Posibilidad de incorporar brazos.

CODIGO	COMPLEMENTO	P.V.P.
FR-RM	RESPALDO MALLA	+30 €/Puesto
FR-BF	BRAZOS FIJOS	+20 €/Puesto
FR-BP	BRAZOS + PALA	+70 €/Puesto
FR-PA	POLIPROPILENO AMARILLO	+6 €/Puesto
FR-PV	POLIPROPILENO VERDE	+6 €/Puesto
FR-PJ	POLIPROPILENO ZANAHORIA	+6 €/Puesto
FR-PZ	POLIPROPILENO AZUL	+6 €/Puesto
FR-PU	PATAS ALUMINIO PULIDO	+47,00 €
FR-PC	PATAS CROMADAS	+25,00 €



IOWA VP3+1

MODELO	RESPALDO	ASIENTO	MECANISMO	BRAZOS	BASE
IOWA V2	Polipropileno	Tapizado	Fijo	Opcionales	2 patas poliamida negra
IOWA V2+1	Polipropileno	Tapizado	Fijo	Opcionales	2 patas poliamida negra
IOWA V3	Polipropileno	Tapizado	Fijo	Opcionales	2 patas poliamida negra
IOWA V3+1	Polipropileno	Tapizado	Fijo	Opcionales	2 patas poliamida negra
IOWA V4	Polipropileno	Tapizado	Fijo	Opcionales	2 patas poliamida negra
IOWA V4+1	Polipropileno	Tapizado	Fijo	Opcionales	2 patas poliamida negra
IOWA V5	Polipropileno	Tapizado	Fijo	Opcionales	2 patas poliamida negra
IOWA VP2	Polipropileno	Polipropileno	Fijo	Opcionales	2 patas poliamida negra
IOWA VP2+1	Polipropileno	Polipropileno	Fijo	Opcionales	2 patas poliamida negra
IOWA VP3	Polipropileno	Polipropileno	Fijo	Opcionales	2 patas poliamida negra
IOWA VP3+1	Polipropileno	Polipropileno	Fijo	Opcionales	2 patas poliamida negra
IOWA VP4	Polipropileno	Polipropileno	Fijo	Opcionales	2 patas poliamida negra
IOWA VP4+1	Polipropileno	Polipropileno	Fijo	Opcionales	2 patas poliamida negra
IOWA VP5	Polipropileno	Polipropileno	Fijo	Opcionales	2 patas poliamida negra

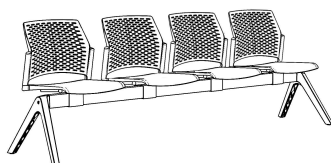

### IOWA

82  
130/205/270/315  
60

Altura / Height / Haut

Anchura / Width / Large

Fondo / Depth / Fond

### PVP POR TAPICERÍAS

MODELO	Grupo 1	Grupo 2	Grupo 3	Piel	T.Cliente
IOWA V2	325 €	341 €	359 €	413 €	322 €
IOWA V2+1	390 €	410 €	429 €	494 €	386 €
IOWA V3	448 €	470 €	494 €	568 €	444 €
IOWA V3+1	513 €	539 €	566 €	650 €	508 €
IOWA V4	574 €	603 €	633 €	728 €	568 €
IOWA V4+1	639 €	671 €	704 €	810 €	633 €
IOWA V5	690 €	725 €	760 €	875 €	683 €

### DATOS ESPECÍFICOS

METRAJE	PESO	VOL.	UD.x BULTO
1,3	17,8	0,4	1
1,3	24,2	0,57	1
1,8	23,9	0,57	1
1,8	29,65	0,75	1
2	29,65	0,75	1
2	36	0,95	1
2,6	35,75	0,95	1

### POLIPROPILENO: Negro, Gris, Blanco

IOWA VP2	295 €
IOWA VP2+1	360 €
IOWA VP3	403 €
IOWA VP3+1	468 €
IOWA VP4	514 €
IOWA VP4+1	579 €
IOWA VP5	615 €

---	16,6	0,4	1
---	23	0,57	1
---	22,7	0,57	1
---	28,7	0,75	1
---	28,45	0,75	1
---	34,85	0,95	1
---	34,55	0,95	1

Bancada con patas en forma de V fabricadas en poliamida negra. Las patas incorporan niveladores y se unen a través de una viga donde se sujeta la estructura de la silla. Asientos y respaldos fabricados en poliamida o tapizados. Posibilidad de incorporar brazos.

CODIGO	COMPLEMENTO	P.V.P.
IO-BF	BRAZOS FIJOS	+20 €/Puesto
IO-BP	BRAZOS + PALA	+70 €/Puesto
IO-PA	POLIPROPILENO AMARILLO	+6 €/Puesto
IO-PV	POLIPROPILENO VERDE	+6 €/Puesto
IO-PJ	POLIPROPILENO ZANAHORIA	+6 €/Puesto
IO-PZ	POLIPROPILENO AZUL	+6 €/Puesto
IO-PU	PATAS ALUMINIO PULIDO	+47,00 €
IO-PC	PATAS CROMADAS	+25,00 €



JAMAICA V4 C/BRAZOS  
PATA ALUMINIO PULIDO



JAMAICA VP4

MODELO	RESPALDO	ASIENTO	MECANISMO	BRAZOS	BASE
JAMAICA V2	Tapizado	Tapizado	Fijo	Opcionales	2 patas poliamida negra
JAMAICA V2+1	Tapizado	Tapizado	Fijo	Opcionales	2 patas poliamida negra
JAMAICA V3	Tapizado	Tapizado	Fijo	Opcionales	2 patas poliamida negra
JAMAICA V3+1	Tapizado	Tapizado	Fijo	Opcionales	2 patas poliamida negra
JAMAICA V4	Tapizado	Tapizado	Fijo	Opcionales	2 patas poliamida negra
JAMAICA V4+1	Tapizado	Tapizado	Fijo	Opcionales	2 patas poliamida negra
JAMAICA V5	Tapizado	Tapizado	Fijo	Opcionales	2 patas poliamida negra
JAMAICA VP2	Polipropileno	Polipropileno	Fijo	Opcionales	2 patas poliamida negra
JAMAICA VP2+1	Polipropileno	Polipropileno	Fijo	Opcionales	2 patas poliamida negra
JAMAICA VP3	Polipropileno	Polipropileno	Fijo	Opcionales	2 patas poliamida negra
JAMAICA VP3+1	Polipropileno	Polipropileno	Fijo	Opcionales	2 patas poliamida negra
JAMAICA VP4	Polipropileno	Polipropileno	Fijo	Opcionales	2 patas poliamida negra
JAMAICA VP4+1	Polipropileno	Polipropileno	Fijo	Opcionales	2 patas poliamida negra
JAMAICA VP5	Polipropileno	Polipropileno	Fijo	Opcionales	2 patas poliamida negra

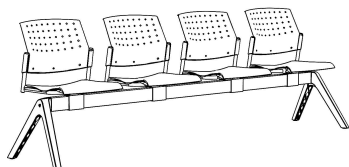

### JAMAICA

84

130/205/270/315

60

Altura / Height / Haut

Anchura / Width / Large

Fondo / Depth / Fond

### PVP POR TAPICERÍAS

MODELO	Grupo 1	Grupo 2	Grupo 3	Piel	T.Cliente
JAMAICA V2	319 €	335 €	352 €	405 €	316 €
JAMAICA V2+1	384 €	403 €	423 €	487 €	380 €
JAMAICA V3	436 €	458 €	481 €	553 €	432 €
JAMAICA V3+1	501 €	526 €	551 €	635 €	495 €
JAMAICA V4	558 €	586 €	615 €	707 €	552 €
JAMAICA V4+1	623 €	654 €	686 €	789 €	616 €
JAMAICA V5	665 €	698 €	733 €	843 €	658 €

POLIPROPILENO: NEGRO		
JAMAICA VP2		275 €
JAMAICA VP2+1		340 €
JAMAICA VP3		370 €
JAMAICA VP3+1		435 €
JAMAICA VP4		470 €
JAMAICA VP4+1		535 €
JAMAICA VP5		555 €

### DATOS ESPECÍFICOS

METRAJE	PESO	VOL.	UD.x BULTO
1,1	17,8	0,4	1
1,1	24,2	0,57	1
1,65	23,9	0,57	1
1,65	29,95	0,75	1
1,8	29,65	0,75	1
1,8	36,05	0,95	1
2,4	35,75	0,95	1
---	16,6	0,4	1
---	23	0,57	1
---	22,7	0,57	1
---	28,7	0,75	1
---	28,45	0,75	1
---	34,85	0,95	1
---	34,55	0,95	1

Bancada con patas en forma de V fabricadas en poliamida negra. Las patas incorporan niveladores y se unen a través de una viga donde se sujeta la estructura de la silla. Asientos y respaldos fabricados en poliamida o tapizados. Posibilidad de incorporar brazos.

CODIGO	COMPLEMENTO	P.V.P.
JA-RM	RESPALDO SIN TAPIZAR	- 7 €/Puesto
JA-RM	RESPALDO MALLA (Modelos VP)	+26 €/Puesto
JA-RM	RESPALDO MALLA (Mod. Tapizados)	+19 €/Puesto
JA-BF	BRAZOS FIJOS	+16,50 €/Puesto
JA-PA	POLIPROPILENO AMARILLO	+6 €/Puesto
JA-PB	POLIPROPILENO BURDEOS	+6 €/Puesto
JA-PG	POLIPROPILENO GRIS	+6 €/Puesto
JA-PV	POLIPROPILENO VERDE	+6 €/Puesto
JA-PZ	POLIPROPILENO AZUL	+6 €/Puesto
JA-PU	PATAS ALUMINIO PULIDO	+47,00 €
JA-PC	PATAS CROMADAS	+25,00 €



VIENA VP4



VIENA VP3+1  
PATAS ALUMINIO PULIDO

### DATOS ESPECÍFICOS

MODELO	RESPALDO - ASIENTO	MECANISMO	BASE	METRAJE	PESO	VOL.	UD.x BULTO
VIENA VP2	Monocarcasa Polipropileno	Fijo	2 patas poliamida negra	---	16,6	0,4	1
VIENA VP2+1	Monocarcasa Polipropileno	Fijo	2 patas poliamida negra	---	23	0,57	1
VIENA VP3	Monocarcasa Polipropileno	Fijo	2 patas poliamida negra	---	22,7	0,57	1
VIENA VP3+1	Monocarcasa Polipropileno	Fijo	2 patas poliamida negra	---	28,7	0,75	1
VIENA VP4	Monocarcasa Polipropileno	Fijo	2 patas poliamida negra	---	28,45	0,75	1
VIENA VP4+1	Monocarcasa Polipropileno	Fijo	2 patas poliamida negra	---	34,85	0,95	1
VIENA VP5	Monocarcasa Polipropileno	Fijo	2 patas poliamida negra	---	34,55	0,95	1

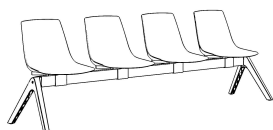

VIENA

81

123/185/246/295

60

Altura / Height / Haut

Anchura / Width / Large

Fondo / Depth / Fond

MODELO	P.V.P.
VIENA VP2	310 €
VIENA VP2+1	375 €
VIENA VP3	430 €
VIENA VP3+1	495 €
VIENA VP4	550 €
VIENA VP4+1	615 €
VIENA VP5	660 €

COLORES POLIPROPILENO: BLANCO,  
GRIS, ANTRACITA, AZUL, VERDE

CODIGO	COMPLEMENTO	P.V.P.
VI-AT	ASIENTO TAPIZADO(GRUPO 1)	+23 €/Puesto
VI-PA	POLIPROPILENO AMARILLO	+6 €/Puesto
VI-PJ	POLIPROPILENO ZANAHORIA	+6 €/Puesto
VI-PU	PATAS ALUMINIO PULIDO	+47,00 €
VI-PC	PATAS CROMADAS	+25,00 €



### DATOS ESPECÍFICOS

MODELO	RESPALDO	ASIENTO	ESTRUCTURA	METRAJE	PESO	VOL.	UD.x BULTO
LORCA 4/2 + 1	Madera	Tapizado	Melamina	2	25	0,75	1
LORCA 4/3	Madera	Tapizado	Melamina	3	30	0,75	1
LORCA 4/3 + 1	Madera	Tapizado	Melamina	3	35	1	1
LORCA 4/4	Madera	Tapizado	Melamina	4	40	1	1
LORCA 4/4 + 1	Madera	Tapizado	Melamina	4	45	1,25	1
LORCA 4/5	Madera	Tapizado	Melamina	5	50	1,25	1



LORCA 3	LORCA 4	LORCA 5
85	85	85
170	230	285
50	50	50

Altura / Height / Haut  
Anchura / Width / Large  
Fondo / Depth / Fond

### PVP POR TAPICERÍAS

MODELO	Grupo 1	Grupo 2	Grupo 3	Piel	T.Cliente
LORCA 4/2 + 1	470 €	494 €	517 €	595 €	466 €
LORCA 4/3	599 €	629 €	660 €	758 €	592 €
LORCA 4/3 + 1	653 €	685 €	720 €	828 €	646 €
LORCA 4/4	783 €	822 €	863 €	993 €	776 €
LORCA 4/4 + 1	834 €	876 €	919 €	1.057 €	825 €
LORCA 4/5	966 €	1.014 €	1.065 €	1.225 €	955 €

INDICAR ORIENTACION DEL RESPALDO

CONSULTAR ELEMENTOS DE ELECTRIFICACION  
EN TARIFA DE ISMOBEL

## TODAS LAS REFERENCIAS SE SUMINISTRAN DESMONTADAS

Bancada fabricada con estructura de bilaminado acabado en cualquier diseño. Respaldos fabricados en madera contrachapada de haya conformada de grosor variable 8-13 mm.  
Asientos tapizados sobre espuma de poliuretano de alta resistencia.

### COMPLEMENTOS OPCIONALES

RESPALDO	ESTRUCTURA	INCREMENTO DEL PRECIO
Barniz otro tono (INCREMENTO POR PUESTO)		+18,00 €
Lacado (INCREMENTO POR PUESTO)		+27,00 €
Sin Respaldo ( DECREMENTO POR PUESTO)		-70,00 €
	Angulo Unión Melamina	+98,00 €
	Jardinera Melamina	+178,00 €

# COMPLEMENTOS



Brazos Fijos **32,50 €**



Brazos Regulables en altura **23,00 €**  
Brazos Regulables en altura blancos **32,50 €**



Brazos Regulables 2D SOFT **29,00 €**



Brazos Regulables 3D DURO **30,00 €**  
Brazos Regulables 3D SOFT **40,00 €**



Brazos Regulables 4D SOFT **50,00 €**



Pistón de gas **15,50 €**  
Pistón taburete **27,00 €**

## BASES . PRECIO SIN RUEDAS



Base silla poliamida **18,00 €**



### Base 5 puntas:

- \* Aluminio pulido **60,00 €**
- \* Pintado blanco **75,00 €**
- \* Pintado negro **75,00 €**



Base Piramidal poliamida: **84,00 €**  
\* Acabado blanco  
\* Acabado negro  
\* Con Ruedas **+16,50 €**



Base 4 Radios Cromada Piramidal: **199,00 €**



Base 5 Radios Cromada  
Piramidal c/c/ruedas: **258,00 €**



Ruedas y topes **2,30 €**  
Ruedas Rodadura blanda **3,50 €**  
Ruedas blancas **3,00 €**  
Ruedas diámetro 65 mm. **3,50 €**



Aro taburete **30,00 €**

## MECANISMOS



Syncro 5 posiciones autopesante  
c/regulación lateral(24H) **85,00 €**



Syncro 5 posiciones **50,00 €**  
Syncro 5 posiciones c/traslat **70,00 €**



Syncro 4 posiciones autopesante **45,00 €**  
Syncro 4 posiciones autopesante  
c/traslat **55,00 €**

CONSULTAR  
DISPONIBILIDAD  
DE OTROS COLORES  
PARA CANTIDADES

ASK FOR  
AVAILABILITY  
FOR OTHER COLORS  
FOR LARGE  
QUANTITIES

VÉRIFIER LA  
DISPONIBILITÉ  
POUR D'AUTRES  
COULEURS POUR  
GRANDES QUANTITÉS

# ACABADOS

*Finishes / Finitions*

- GRUPO 1-  
BONDAI  
BERING  
BALI  
GOYA  
BASIC F.R.

-GRUPO 2-  
PUMA F.R.  
RADIO  
SAMBA F.R.  
TORINO

-GRUPO 3-  
VALENCIA  
SQUARE F.R.  
KING ELAST

PIEL  
MALLA  
MALLA NICEA / ODESA M / RODOS

# BONDAI [GRUPO 1]

ANCHO: 140 cm  
 PESO: 350 gr/ml  
 100% Poliéster  
 Inflamabilidad: EN 1021-1/2  
 Resistencia Abrasión 150.000 c.Martindale



OEKO-TEX®  
 CONFIDENCE IN TEXTILES  
**STANDARD 100**  
 073313.0 CENTROCOT  
 Tested for harmful substances.  
 www.oeko-tex.com/standard100



1005



3013



4037



4011



8033

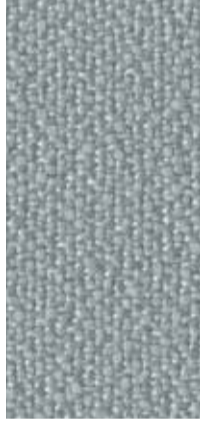

8078



7021

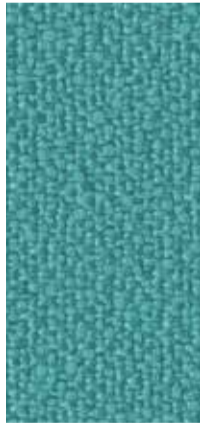

7026



6071

# BERING [GRUPO 1]

ANCHO: 140 cm  
 PESO: 605 gr/ml  
 100% PVC  
 100% Poliéster (base)  
 Inflamabilidad: EN 1021-1 (Cigarrillo)  
 Resistencia Abrasión 100.000 c.Martindale

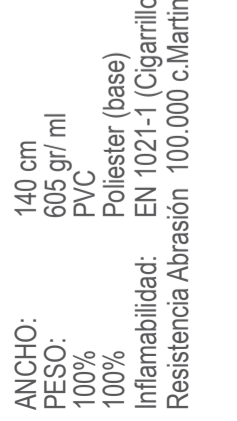

45



13



00



93



35



29



20

# BALI [GRUPO 1]

ANCHO: 140 cm  
 PESO: 420 gr/ml  
 100% Poliolefina  
 Inflamabilidad: EN 1021-1 2006 (Cigarrillo)  
 Resistencia Abrasión 100.000 c.Martindale

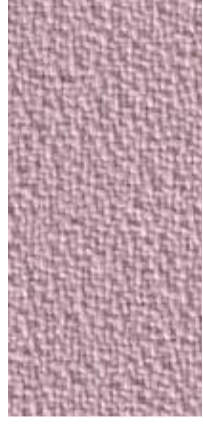

710



104

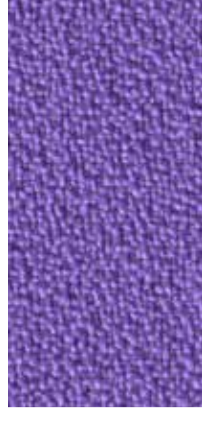

308

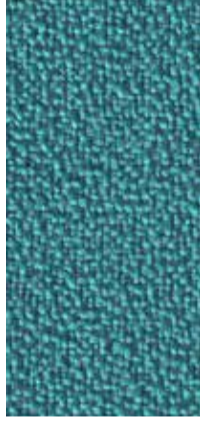

39



861

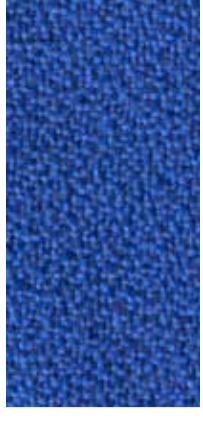

229



933

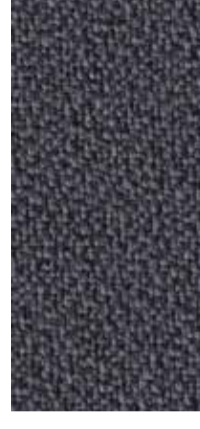

600



840

# GOYA [GRUPO 1]

ANCHO: 140 cm  
 PESO: 355 gr/ml  
 100% Poliolefina  
 Inflamabilidad: EN 1021-1 2006 (Cigarrillo)  
 Resistencia Abrasión 100.000 c.Martindale

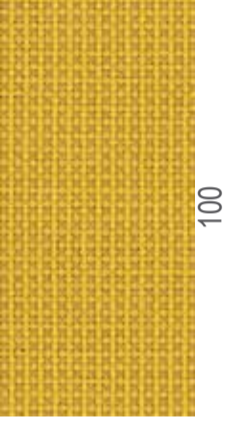

100

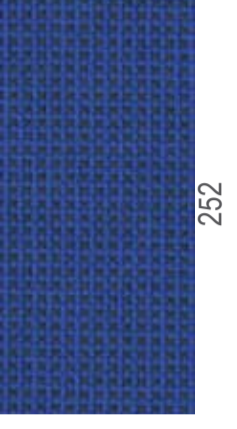

252

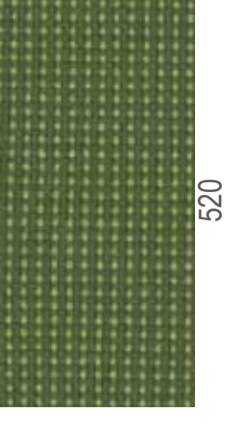

520

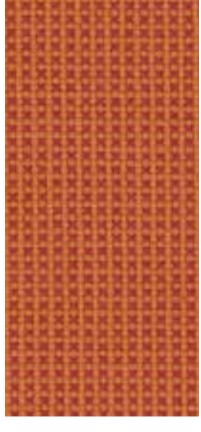

310



330



840

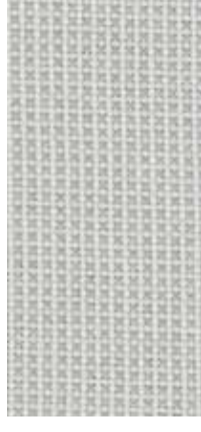

016

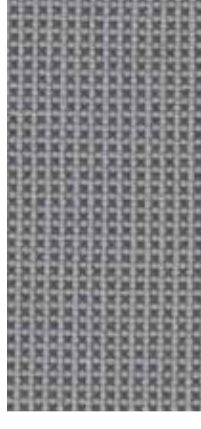

647

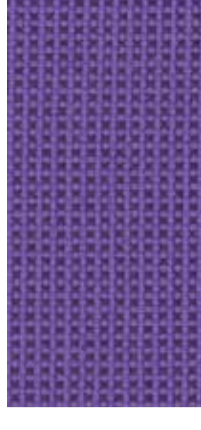

762

# BASIC F.R. [GRUPO 1]



ANCHO: 140 cm  
 PESO: 470 gr/ml  
 100% Poliéster

Ignifugo: EN 1021-1/2  
 Resistencia Abrasión 100.000 c.Martindale



106



088



755



462



098



077



005



084



170



315



108



009

# PUMA F.R. [GRUPO 2]



# TORINO [GRUPO 2]

ANCHO: 140 cm  
 PESO: 365 gr/ m<sup>l</sup>  
 100% Poliéster TREVIRA CS  
 EN 1021-1/2  
 Resistencia Abrasión: 70.000 c.Martindale

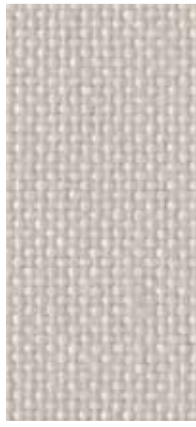

9121

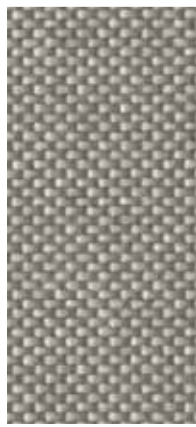

9801



9312



9701

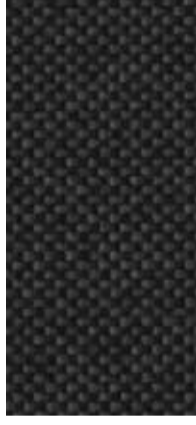

9838

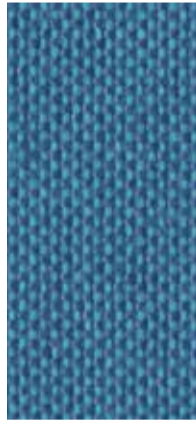

9606



# SQUARE F.R. [GRUPO 3]

ANCHO: 140 cm  
 PESO: 553 gr/ m<sup>l</sup>  
 100% Poliéster FR  
 EN 1021-1/2  
 Resistencia Abrasión: 100.000 c.Martindale



458



009

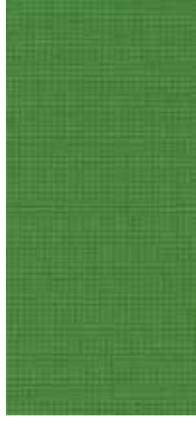

559



606



379



208

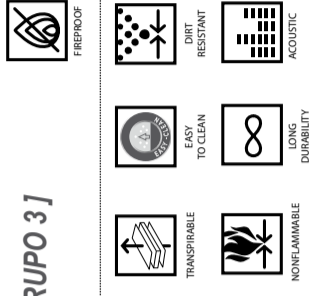

ACABADOS

# VALENCIA [GRUPO 3]

ANCHO: 137 cm  
 PESO: 650 gr/ m<sup>2</sup>  
 100% PVC  
 100% Poliéster (base)  
 EN 1021-1/2  
 Resistencia abrasión: 300.000 c.Martindale



67



13

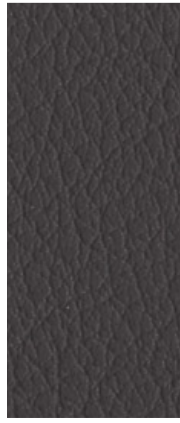

20



74



32

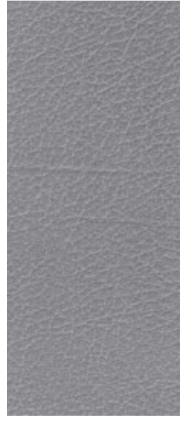

45



35

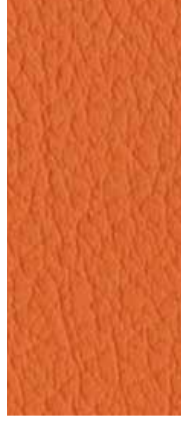

19



01



# KING ELAST [GRUPO 3]

ANCHO: 140 cm  
 PESO: 365 gr/ m<sup>2</sup>  
 100% Poliéster (base)  
 EN 1021-1/2  
 Resistencia abrasión: 80.000 c.Martindale

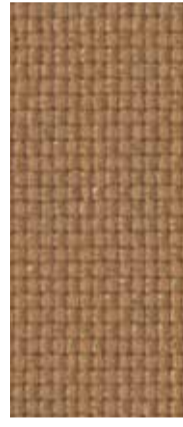

2014



4017



7019



3094

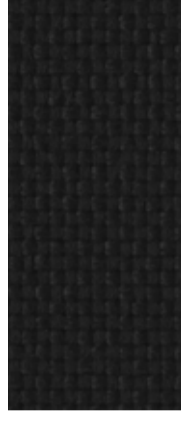

8033

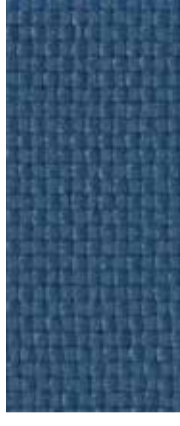

6016



4027

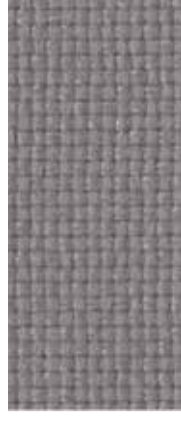

8014

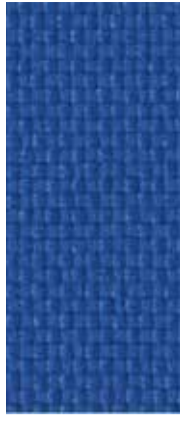

6071



# PIEL

MEDIDA DE PIEZA: 4,5 m<sup>2</sup>

Limpieza: Paño Húmedo



Negro



Marrón

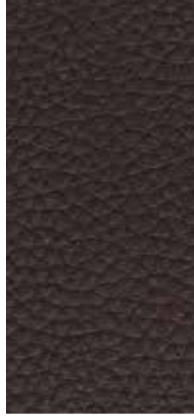

Chocolate

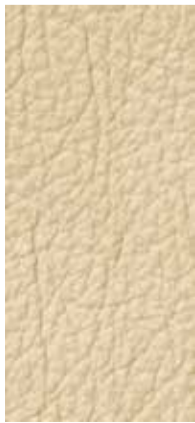

Beige



430



447



# MALLA



ANCHO: 150 cm  
 PESO: 340gr/ ml  
 100% Poliéster  
 EN 1021-1/2  
 Resistencia Abrasión: 90.000 c.Martindale

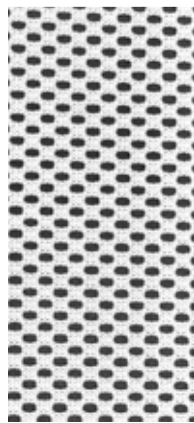
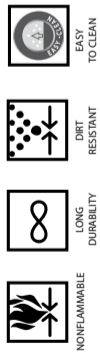

BLANCO

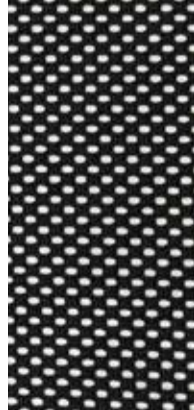

NEGRO



AZUL



BURDEOS



VERDE



VISÓN



MELOCOTÓN



GRIS

# MALLA NICEA / ODESA / RODOS



ANCHO: 140 cm  
 PESO: 460 gr/ ml  
 100% PES  
 Resistencia Abrasión: 100.000 c.Martindale

Tejido únicamente aplicable para el respaldo de la silla Nicea

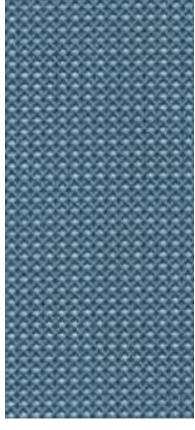

090



001



333

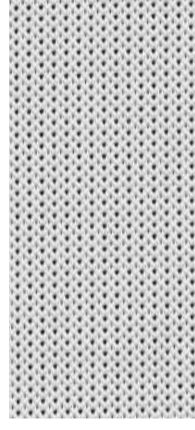

1000

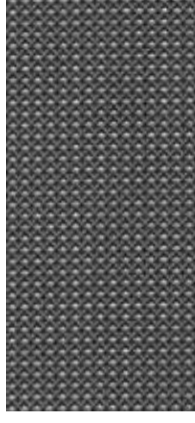

052

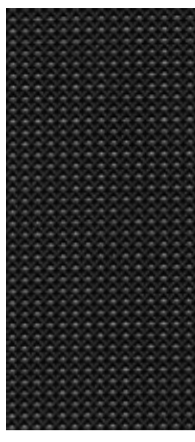

9000



## NOTA:

Los colores de estas páginas pueden sufrir algún cambio con respecto a la muestra real debido a los procesos de impresión del catálogo.

Solicite una muestra física si desea asegurarse del acabado final.

## NOTE:

The colors on these pages may have some difference from the physical sample due to catalogue printing procedure.

Request a physical sample if you want to make sure the final finish.

## NOTE:

Les couleurs de ces pages peuvent avoir un changement avec rapport à l'échantillon réel en raison de l'impression du catalogue.

Vous pouvez nous solliciter un échantillon physique pour vous assurer du terminaison finale.



# THE COLLEC- TION

## TARIFA 2020.0

**JDM**  
seating

*Grupo Ismobel*

Polígono La Portalada II  
C/ Cordonera 5  
26006 LOGROÑO (La Rioja)  
T. +34 941 230 752 / F. +34 941 248 977  
ismobel@ismobel.com

[ismobel.com](http://ismobel.com)



**40** 2021  
1981

*Grupo Ismobel*

